

SANDWELL MK3 LEVEL ACCESS SHOWER (655/760 MODELS)

HOW TO ORDER

- 1 CHOOSE SHOWER TRAY SIZE**
- 2 CHOOSE TRAY PART NUMBER & ASSOCIATED WASTE**
 - G1** Gravity Invawaste trap (Included & shown on p23-24)
 - P1** (Whale pump needs to be ordered separately for this option - see p26-29)
- 3 CHOOSE DOOR KIT OPTION**

Door and enclosure kit contents:

- Door kit (c/w rising butt hinge on Trifold door)
- Half height fixed panel
- Assistance pole (1950mm) to Curtain Rail (floor to Ceiling poles are available as an option - additional £15. Please confirm height requirement)
- Curtain Track and Hooks to suit door option
- White Shower Curtain
- Fitting instructions
- See p130 for Shower units (optional extra)

Shower tray contents:

- White shower tray (can be trimmed to a minimum of 1200mm on site) (coloured shower trays available in any colour to special order. A £200 charge applies. Extended delivery time applies.)
- Tray Edging Cover Strips
- Waste (only supplied with gravity waste shower tray)
- Fitting instructions

IMPORTANT NOTE: Trays and door kits are coded separately - for example: To order a Left hand 655 tray with Invawaste and Trifold enclosure - Order tray (i.e Part number IDISAN44) **PLUS** door kit (i.e Part number 00-090113305).

LEFT HAND TRAYS To order tick the relevant circle and fax back.

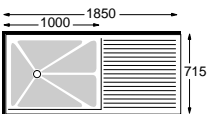
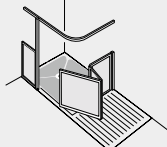
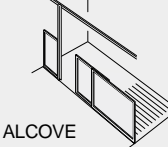
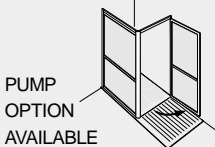
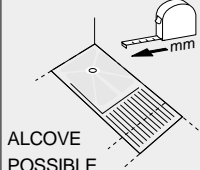
1 SHOWER TRAY SIZE	2 TRAY PART NUMBER	3 TRIFOLD DOOR KIT	SLIDE/FOLD DOOR KIT	IMPRESSIONS COLLECTION TRAY/DOOR KIT	SPECIAL DOOR KIT
LEFT HAND 655 TRAY Price £354 (both trays) 	<input type="radio"/> IDISAN44 <input type="checkbox"/> G1 c/w Invawaste <input type="radio"/> IDISAN44LW <input type="checkbox"/> P1 Low Waste (See p26-29 for waste pump details)	<input type="radio"/> 00-090113305 Price £461 	<input type="radio"/> 00-090113301 Price £461  ALCOVE	<input type="radio"/> SEE PAGE 80-83  PUMP OPTION AVAILABLE	<input type="radio"/> SEE PAGE 49  ALCOVE POSSIBLE

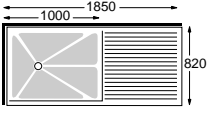
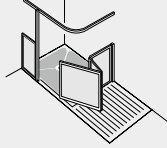
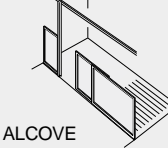
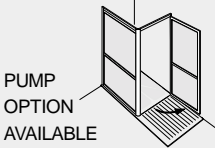
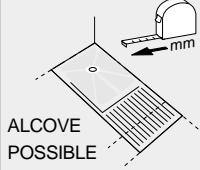
1 SHOWER TRAY SIZE	2 TRAY PART NUMBER	3 TRIFOLD DOOR KIT	SLIDE/FOLD DOOR KIT	IMPRESSIONS COLLECTION TRAY/DOOR KIT	SPECIAL DOOR KIT
LEFT HAND 760 TRAY Price £354 (both trays) 	<input type="radio"/> IDISA40 <input type="checkbox"/> G1 c/w Invawaste <input type="radio"/> IDISA40LW <input type="checkbox"/> P1 Low waste (See p26-29 for waste pump details)	<input type="radio"/> 00-090213305 Price £461 	<input type="radio"/> 00-090213306 Price £461  ALCOVE	<input type="radio"/> SEE PAGE 15  PUMP OPTION AVAILABLE	<input type="radio"/> SEE PAGE 20  ALCOVE POSSIBLE

PARTS

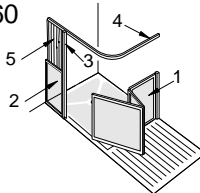
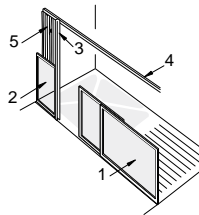
LEFT HAND 655/760 (TRIFOLD DOOR KIT)  <p><i>Notes:</i> Illustration left applies to both 655 and 760 models For shower tray part numbers see above. Invawaste & Whale pump options - see pages 23-24, 26-29</p>	LEFT HAND 655/760 (SLIDE/FOLD DOOR KIT)  <p><i>Notes:</i> Illustration left applies to both 655 and 760 models For shower tray part numbers see above. Invawaste & Whale pump options - see pages 23-24, 26-29</p>
----------------------------------------------------------------------------------------------------------------------------------------------------------------------------------------------------------------------------------------------------------------------------------------------------------------------------------------	--------------------------------------------------------------------------------------------------------------------------------------------------------------------------------------------------------------------------------------------------------------------------------------------------------------------------------------------

LEFT HAND 655 TRAY			LEFT HAND 655 TRAY		
DESCRIPTION	PART NUMBER	PRICE	PART NUMBER	DESCRIPTION	PRICE
<input type="radio"/> 02-100233302	1. Door	£439.89	<input type="radio"/> IDASSD01W	1. Door	£439.88
<input type="radio"/> 03-040213301	2. Jamb panel	£66.11	<input type="radio"/> IDASJS03W	2. Jamb panel	£91.88
<input type="radio"/> 04-030013001	3. Pole set	£62.55	<input type="radio"/> IDAPK01W	3. Pole set	£62.55
<input type="radio"/> IDGRL3925W	4. Curtain rail	£40.44	<input type="radio"/> IDGRS72W	4. Curtain rail	£23
<input type="radio"/> IDGSS22	5. Curtain	£32	<input type="radio"/> IDGSS01	5. Curtain	£22
LEFT HAND 760 TRAY			LEFT HAND 760 TRAY		
<input type="radio"/> 02-100233301	1. Door	£439.89	<input type="radio"/> IDASSD01W	1. Door	£439.89
<input type="radio"/> 03-040213301	2. Jamb panel	£66.11	<input type="radio"/> IDASJS03W	2. Jamb panel	£91.88
<input type="radio"/> 04-030013001	3. Pole set	£62.55	<input type="radio"/> IDAPK01W	3. Pole set	£62.55
<input type="radio"/> IDGRL3930W	4. Curtain rail	£38	<input type="radio"/> IDGRS72W	4. Curtain rail	£23
<input type="radio"/> IDGSS22	5. Curtain	£32	<input type="radio"/> IDGSS01	5. Curtain	£22

Note: Spare parts for Impressions Collection Door Kits/Special Door Kits - Please refer to Technical Helpdesk on 01869 365500

SYMBOLS:

Bulk/oversized item



Made to order (see P192)



Tel: 0800 917 0399

www.chilterninvadex.co.uk

Fax: +44 (0) 1869 365588

sales@chilterninvadex.co.uk

SANDWELL MK3 LEVEL ACCESS SHOWER (655/760 MODELS)

HOW TO ORDER

1 CHOOSE SHOWER TRAY SIZE
2 CHOOSE TRAY PART NUMBER & ASSOCIATED WASTE
G1 Gravity Invawaste trap (Included & shown on p23-24)
P1 (Whale pump needs to be ordered separately for this option - see p26-29)
3 CHOOSE DOOR KIT OPTION

Door and enclosure kit contents:

- Door kit (c/w rising butt hinge on Trifold door)
- Half height fixed panel
- Assistance pole (1950mm) to Curtain Rail (floor to Ceiling poles are available as an option - additional £15. Please confirm height requirement)
- Curtain Track and Hooks to suit door option
- White Shower Curtain
- Fitting instructions
- See p130 for Shower units (optional extra)



Shower tray contents:

- White shower tray (can be trimmed to a minimum of 1200mm on site) (coloured shower trays available in any colour to special order. A £200 charge applies. Extended delivery times apply.)
- Tray Edging Cover Strips
- Waste (only supplied with gravity waste shower tray)
- Fitting instructions

IMPORTANT NOTE: Trays and door kits are coded separately - for example: To order a Right hand 655 tray with Invawaste and Trifold enclosure - Order tray (i.e Part number IDISAN46) **PLUS** door kit (i.e Part number 00-090133305).

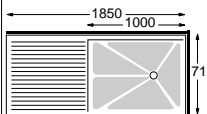
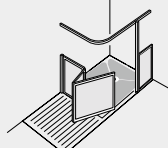
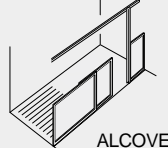
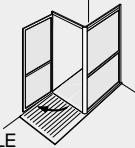
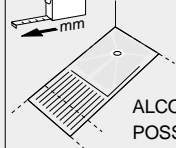
RIGHT HAND TRAYS To order tick the relevant circle and fax back.

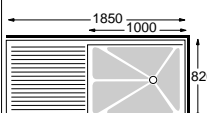
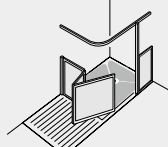
1 SHOWER TRAY SIZE	2 TRAY PART NUMBER	TRIFOLD DOOR KIT	SLIDE/FOLD DOOR KIT	IMPRESSIONS COLLECTION TRAY/DOOR KIT	SPECIAL DOOR KIT
RIGHT HAND 655 TRAY Price £354 (both trays) 	<input type="radio"/> IDISAN46 G1 c/w Invawaste <input type="radio"/> IDISAN46LW P1 Low Waste (See p26-29 for waste pump details)	<input type="radio"/> 00-090133305 Price £461 	<input type="radio"/> 00-090133301 Price £461  ALCOVE	<input type="radio"/> SEE PAGE 80-83 PUMP OPTION AVAILABLE 	<input type="radio"/> SEE PAGE 49  ALCOVE POSSIBLE

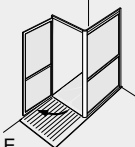
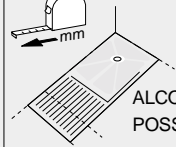

1 SHOWER TRAY SIZE	2 TRAY PART NUMBER	TRIFOLD DOOR KIT	SLIDE/FOLD DOOR KIT	IMPRESSIONS COLLECTION TRAY/DOOR KIT	SPECIAL DOOR KIT
RIGHT HAND 760 TRAY Price £354 (both trays) 	<input type="radio"/> IDISA42 G1 c/w Invawaste <input type="radio"/> IDISA42LW P1 Low waste (See p26-29 for waste pump details)	<input type="radio"/> 00-090233305 Price £461 	<input type="radio"/> 00-090233306 Price £461  ALCOVE	<input type="radio"/> SEE PAGE 80-83 PUMP OPTION AVAILABLE 	<input type="radio"/> SEE PAGE 49  ALCOVE POSSIBLE

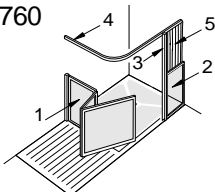
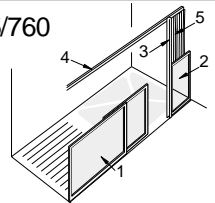
PARTS

RIGHT HAND 655/760 (TRIFOLD DOOR KIT) 	RIGHT HAND 655/760 (SLIDE/FOLD DOOR KIT) 
Notes: Illustration left applies to both 655 and 760 models For shower tray part numbers see above. Invawaste & Whale pump options - see pages 23-24, 26-29	Notes: Illustration left applies to both 655 and 760 models For shower tray part numbers see above. Invawaste & Whale pump options - see pages 23-24, 26-29

RIGHT HAND 655 TRAY			RIGHT HAND 655 TRAY		
DESCRIPTION	PART NUMBER	PRICE	PART NUMBER	DESCRIPTION	PRICE
<input type="radio"/> 02-100213302	1. Door	£439.89	<input type="radio"/> IDASSD02W	1. Door	£439.88
<input type="radio"/> 03-040233301	2. Jamb panel	£66.11	<input type="radio"/> IDASJS04W	2. Jamb panel	£91.88
<input type="radio"/> 04-030033001	3. Pole set	£62.55	<input type="radio"/> IDAPK02W	3. Pole set	£62.55
<input type="radio"/> IDGRL3925W	4. Curtain rail	£40.44	<input type="radio"/> IDGRS72W	4. Curtain rail	£23
<input type="radio"/> IDGSS22	5. Curtain	£32	<input type="radio"/> IDGSS01	5. Curtain	£22
RIGHT HAND 760 TRAY			RIGHT HAND 760 TRAY		
<input type="radio"/> 02-100213301	1. Door	£439.89	<input type="radio"/> IDASSD02W	1. Door	£439.89
<input type="radio"/> 03-040233301	2. Jamb panel	£66.11	<input type="radio"/> IDASJS04W	2. Jamb panel	£91.88
<input type="radio"/> 04-030033001	3. Pole set	£62.55	<input type="radio"/> IDAPK02W	3. Pole set	£62.55
<input type="radio"/> IDGRL3930W	4. Curtain rail	£38	<input type="radio"/> IDGRS72W	4. Curtain rail	£23
<input type="radio"/> IDGSS22	5. Curtain	£32	<input type="radio"/> IDGSS01	5. Curtain	£22

Note: Spare parts for Impressions Collection Door Kits/Special Door Kits - Please refer to Technical Helpdesk on 01869 365500

SYMBOLS: Bulk/oversized item  Made to order (see P192) 	Tel: 0800 917 0399 www.chilterninvadex.co.uk	Fax: +44 (0) 1869 365588 sales@chilterninvadex.co.uk
--------------------------------------------------------------------------------------------------------------------------------------------------------------------------------------------------------------------------------------------	-------------------------------------------------	---------------------------------------------------------

WESTDALE LEVEL ACCESS SHOWER (655/760 MODELS)

HOW TO ORDER

- 1 CHOOSE SHOWER TRAY SIZE**
- 2 CHOOSE TRAY PART NUMBER & ASSOCIATED WASTE**
 - G1** Gravity Invawaste trap (Included & shown on p23-24)
 - P1** (Whale pump needs to be ordered separately for this option - see p26-29)
- 3 CHOOSE DOOR KIT OPTION**

Door and enclosure kit contents:

- Door kit (c/w rising butt hinge on Trifold door)
- Half height fixed panel
- Assistance pole (1950mm) to Curtain Rail (floor to Ceiling poles are available as an option - additional £15. Please confirm height requirement)
- Curtain Track and Hooks to suit door option
- White Shower Curtain
- Fitting instructions
- See p130 for Shower units (optional extra)



Shower tray contents:

- White shower tray (can be trimmed to a minimum of 1200mm on site) (coloured shower trays available in any colour to special order. A £200 charge applies. Extended delivery times apply.)
- Tray Edging Cover Strips
- Waste (only supplied with gravity waste shower tray)
- Fitting instructions

IMPORTANT NOTE: Trays and door kits are coded separately - for example: To order a Left hand 655 tray with Invawaste and Trifold enclosure - Order tray (i.e Part number IDIWN01) **PLUS** door kit (i.e Part number 00-060113305).

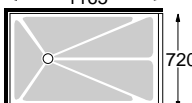
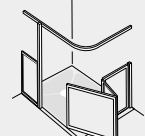
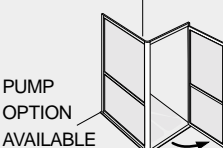
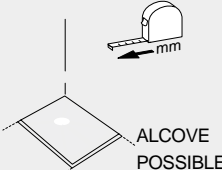
LEFT HAND TRAYS To order tick the relevant circle and fax back.

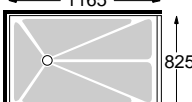
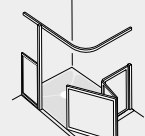
1 SHOWER TRAY SIZE	2 TRAY PART NUMBER	3 TRIFOLD DOOR KIT	IMPRESSIONS COLLECTION TRAY/DOOR KIT	SPECIAL DOOR KIT
LEFT HAND 655 TRAY Price £321.90 (all trays) 	<input type="radio"/> IDIWN01 <input type="checkbox"/> G1 c/w Invawaste <input type="radio"/> IDIWN01LW <input type="checkbox"/> P1 Low Waste (See p26-29 for waste pump details)	<input type="radio"/> 00-060113305 Price £493.10 	<input type="radio"/> SEE PAGE 78-79  PUMP OPTION AVAILABLE	<input type="radio"/> SEE PAGE 49  ALCOVE POSSIBLE

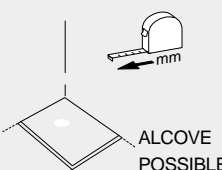
1 SHOWER TRAY SIZE	2 TRAY PART NUMBER	3 TRIFOLD DOOR KIT	IMPRESSIONS COLLECTION TRAY/DOOR KIT	SPECIAL DOOR KIT
LEFT HAND 760 TRAY Price £321.90 (all trays) 	<input type="radio"/> IDIWS01 <input type="checkbox"/> G1 c/w Invawaste <input type="radio"/> IDIWS01LW <input type="checkbox"/> P1 Low waste (See p26-29 for waste pump details)	<input type="radio"/> 00-060213305 Price £493.10 	<input type="radio"/> SEE PAGE 78-79  PUMP OPTION AVAILABLE	<input type="radio"/> SEE PAGE 49  ALCOVE POSSIBLE

PARTS

LEFT HAND 655/760 (TRIFOLD DOOR KIT)

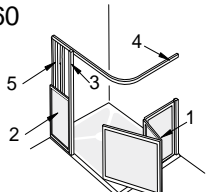

Notes:
 Illustration left applies to both 655 and 760 models
 For shower tray part numbers see above.
 Invawaste & Whale pump options - see pages 23-24, 26-29

LEFT HAND 655 TRAY

DESCRIPTION	PART NUMBER	PRICE
<input type="radio"/> 02-100233302	1. Door	£439.89
<input type="radio"/> 03-040213302	2. Jamb panel	£83
<input type="radio"/> 04-030013001	3. Pole set	£62.55
<input type="radio"/> IDGRL4325W	4. Curtain rail	£38
<input type="radio"/> IDGSS22	5. Curtain	£32

LEFT HAND 760 TRAY

<input type="radio"/> 02-100233301	1. Door	£439.89
<input type="radio"/> 03-040213302	2. Jamb panel	£83
<input type="radio"/> 04-030013001	3. Pole set	£62.55
<input type="radio"/> IDGRL4330W	4. Curtain rail	£38
<input type="radio"/> IDGSS22	5. Curtain	£32

Note: Spare parts for Impressions Collection Door Kits/Special Door Kits - Please refer to Technical Helpdesk on 01869 365500

SYMBOLS:

Bulk/oversized item



Made to order (see P192)



Tel: 0800 917 0399

www.chilterninvadex.co.uk

Fax: +44 (0) 1869 365588

sales@chilterninvadex.co.uk

WESTDALE LEVEL ACCESS SHOWER (655/760 MODELS)

HOW TO ORDER

- 1 CHOOSE SHOWER TRAY SIZE
- 2 CHOOSE TRAY PART NUMBER & ASSOCIATED WASTE
 - G1 Gravity Invawaste trap
(Included & shown on p23-24)
 - P1 (Whale pump needs to be ordered separately for this option - see p26-29)
- 3 CHOOSE DOOR KIT OPTION

Door and enclosure kit contents:

- Door set (c/w rising butt hinge on Trifold door)
- Half height fixed panel
- Assistance pole (1950mm) to Curtain Rail (floor to Ceiling pole available as an option - additional £15. Please confirm height requirement)
- Curtain Track and Hooks to suit door option
- White Shower Curtain
- Fitting instructions
- See p130 for Shower units (optional extra)

Shower tray contents:

- White shower tray (can be trimmed to a minimum of 1200mm on site) (coloured shower trays available in any colour to special order. A £200 charge applies. Extended delivery times apply.)
- Tray Edging Cover Strips
- Waste (only supplied with gravity waste shower tray)
- Fitting instructions

IMPORTANT NOTE: Trays and door kits are coded separately - for example: To order a Left hand 655 tray with Invawaste and Trifold enclosure - Order tray (i.e Part number IDIWN03) **PLUS** door kit (i.e Part number 00-060133305).

RIGHT HAND TRAYS To order tick the relevant circle and fax back.

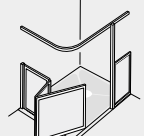
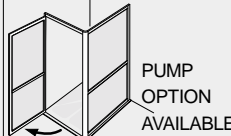
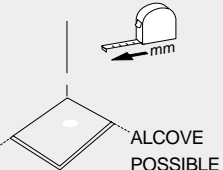
1 SHOWER TRAY SIZE	2 TRAY PART NUMBER	3 TRIFOLD DOOR KIT	IMPRESSIONS COLLECTION TRAY/DOOR KIT	SPECIAL DOOR KIT
RIGHT HAND 655 TRAY Price £321.90 (all trays) 	<input type="radio"/> IDIWN03 G1 c/w Invawaste <input type="radio"/> IDIWN03LW P1 Low Waste (See p26-29 for waste pump details)	<input type="radio"/> 00-060133305 Price £493.10 	<input type="radio"/> SEE PAGE 78-79 	<input type="radio"/> SEE PAGE 49 

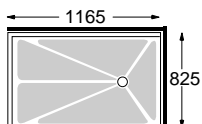
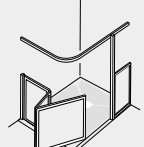
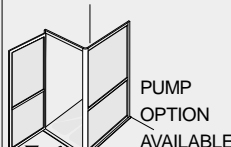
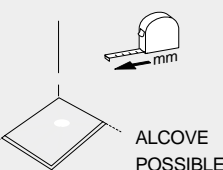
1 SHOWER TRAY SIZE	2 TRAY PART NUMBER	3 TRIFOLD DOOR KIT	IMPRESSIONS COLLECTION TRAY/DOOR KIT	SPECIAL DOOR KIT
RIGHT HAND 760 TRAY Price £321.90 (all trays) 	<input type="radio"/> IDIWS03 G1 c/w Invawaste <input type="radio"/> IDIWS03LW P1 Low waste (See p26-29 for waste pump details)	<input type="radio"/> 00-060233305 Price £493.10 	<input type="radio"/> SEE PAGE 78-79 	<input type="radio"/> SEE PAGE 49 

PARTS

RIGHT HAND 655/760 (TRIFOLD DOOR KIT)

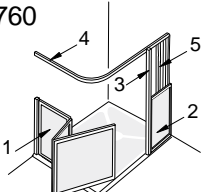

Notes:
 Illustration left applies to both 655 and 760 models
 For shower tray part numbers see above.
 Invawaste & Whale pump options - see pages 23-24, 26-29



RIGHT HAND 655 TRAY

DESCRIPTION	PART NUMBER	PRICE
<input type="radio"/> 02-100213302	1. Door	£439.89
<input type="radio"/> 03-040233302	2. Jamb panel	£83
<input type="radio"/> 04-030033001	3. Pole set	£62.55
<input type="radio"/> IDGRL4325W	4. Curtain rail	£40.44
<input type="radio"/> IDGSS22	5. Curtain	£32

RIGHT HAND 760 TRAY

<input type="radio"/> 02-100213301	1. Door	£439.89
<input type="radio"/> 03-040233302	2. Jamb panel	£83
<input type="radio"/> 04-030033001	3. Pole set	£62.55
<input type="radio"/> IDGRL4330W	4. Curtain rail	£38
<input type="radio"/> IDGSS22	5. Curtain	£32

Note: Spare parts for Impressions Collection Door Kits/Special Door Kits - Please refer to Technical Helpdesk on 01869 365500

SYMBOLS: Bulk/oversized item  Made to order (see P192) 	Tel: 0800 917 0399 www.chilterninvadex.co.uk	Fax: +44 (0) 1869 365588 sales@chilterninvadex.co.uk
--------------------------------------------------------------------------------------------------------------------------------------------------------------------------------------------------------------------------------------------	-------------------------------------------------------------------------------------------------------	-----------------------------------------------------------------------------------------------------------------

WESTDALE LEVEL ACCESS SHOWER (850 MODEL)

HOW TO ORDER

- 1 CHOOSE SHOWER TRAY SIZE**
- 2 CHOOSE TRAY PART NUMBER & ASSOCIATED WASTE**
 - G1** Gravity Invawaste trap (Included & shown on p23-24)
 - P1** (Whale pump needs to be ordered separately for this option - see p26-29)
- 3 CHOOSE DOOR KIT OPTION**

Door and enclosure kit contents:

- Door kit (c/w Trifold door)
- Half height fixed panels
- Assistance poles (1950mm) to Curtain Rail (floor to Ceiling poles available as an option - additional £15. Please confirm height requirement)
- Curtain Track and Hooks to suit door option
- White Shower Curtain
- Fitting instructions
- See p130 for Shower units (optional extra)

Shower tray contents:

- White shower tray (can be trimmed to a minimum of 1200mm on site) (coloured shower trays available in any colour to special order. A £200 charge applies.)
- Tray Edging Cover Strips
- Waste (only supplied with gravity waste shower tray)
- Fitting instructions

IMPORTANT NOTE: Trays and door kits are coded separately - for example: To order a Left hand 850 tray with Invawaste and Trifold enclosure - Order tray (i.e Part number IDISW12) **PLUS** door kit (i.e Part number 00-060913301).

LEFT HAND TRAYS To order tick the relevant circle and fax back.

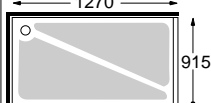
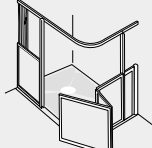
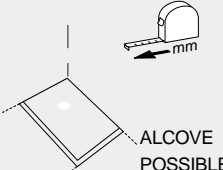
1 SHOWER TRAY SIZE	2 TRAY PART NUMBER	3 TRIFOLD DOOR KIT	SPECIAL DOOR KIT		
LEFT HAND 850 TRAY Price £335.20 	<input type="radio"/> IDISW12 <input type="checkbox"/> G1 c/w Invawaste <input type="radio"/> IDISW12LW <input type="checkbox"/> P1 Low waste (See p26-29 for waste pump details)	<input type="radio"/> 00-060913301 Price £479.80 	<input type="radio"/> SEE PAGE 49 		

PARTS

DESCRIPTION	PART NUMBER	PRICE	
<input type="radio"/> IDATD06W	1. Door	£439.89	
<input type="radio"/> IDAWJ05W	2. Jamb panel (Large)	£90.40	
<input type="radio"/> IDAWD8501W	3. Jamb panel (small)	£90.40	
<input type="radio"/> IDASWP02W	4. Pole set	£95.40	
<input type="radio"/> IDGRL4733W	5. Curtain rail	£35	
<input type="radio"/> IDGSS22	6. Curtain	£32	

LEFT HAND 850 (TRIFOLD DOOR KIT)

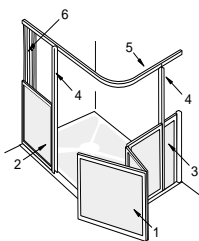

Notes:
For shower tray part numbers see above.
Invawaste & Whale pump options - see pages 23-24, 26-29

SYMBOLS:

Bulk/oversized item



Made to order (see P192)



Tel: 0800 917 0399

www.chilterninvadex.co.uk

Fax: +44 (0) 1869 365588

sales@chilterninvadex.co.uk

WESTDALE LEVEL ACCESS SHOWER (850 MODEL)

HOW TO ORDER

1 CHOOSE SHOWER TRAY SIZE

2 CHOOSE TRAY PART NUMBER & ASSOCIATED WASTE

- G1** Gravity Invawaste trap
(Included & shown on p23-24)
- P1** (Whale pump needs to be ordered separately for this option - see p26-29)

3 CHOOSE DOOR KIT OPTION

Door and enclosure kit contents:

- Door kit (c/w Trifold door)
- Half height fixed panels
- Assistance poles (1950mm) to Curtain Rail (floor to Ceiling poles available as an option - additional £15. Please confirm height requirement)
- Curtain Track and Hooks to suit door option
- White Shower Curtain
- Fitting instructions
- See p130 for Shower units (optional extra)

Shower tray contents:

- White shower tray (can be trimmed to a minimum of 1200mm on site) (coloured shower trays available in any colour to special order. A £200 charge applies.)
- Tray Edging Cover Strips
- Waste (only supplied with gravity shower tray)
- Fitting instructions

IMPORTANT NOTE: Trays and door kits are coded separately - for example: To order a Left hand 850 tray with Invawaste and Trifold enclosure - Order tray (i.e Part number IDISW13) **PLUS** door kit (i.e Part number 00-060933301).

RIGHT HAND TRAYS To order tick the relevant circle and fax back.

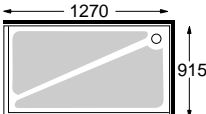
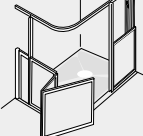
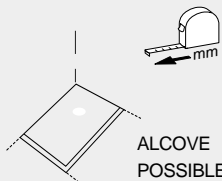
1 SHOWER TRAY SIZE	2 TRAY PART NUMBER	3 TRIFOLD DOOR KIT	SPECIAL DOOR KIT		
RIGHT HAND 850 TRAY Price £335.20 	<input type="radio"/> IDISW13 <input type="checkbox"/> G1 c/w Invawaste <input type="radio"/> IDISW13LW <input type="checkbox"/> P1 Low waste (See p26-29 for waste pump details)	<input type="radio"/> 00-060933301 Price £479.80 	<input type="radio"/> SEE PAGE 49 		

PARTS

DESCRIPTION	PART NUMBER	PRICE	
<input type="radio"/> IDATD05W	1. Door	£439.89	
<input type="radio"/> IDAWJ06W	2. Jamb panel (Large)	£90.40	
<input type="radio"/> IDAWD8503W	3. Jamb panel (small)	£90.40	
<input type="radio"/> IDASWP01W	4. Pole set	£95.40	
<input type="radio"/> IDGRL4733W	5. Curtain rail	£35	
<input type="radio"/> IDGSS22	6. Curtain	£32	

RIGHT HAND 850 (TRIFOLD DOOR KIT)

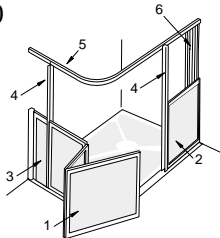

Notes:
For shower tray part numbers see above.
Invawaste & Whale pump options - see pages 23-24, 26-29

SYMBOLS:

Bulk/oversized item



Made to order (see P192)



Tel: 0800 917 0399

www.chilterninvadex.co.uk

Fax: +44 (0) 1869 365588

sales@chilterninvadex.co.uk

WESTDALE LEVEL ACCESS SHOWER (1000 MODEL)

HOW TO ORDER

1 CHOOSE SHOWER TRAY SIZE

2 CHOOSE TRAY PART NUMBER & ASSOCIATED WASTE

G1 Gravity Invawaste trap
(Included & shown on p23-24)

P1 (Whale pump needs to be ordered separately for this option - see p26-29)

3 CHOOSE DOOR KIT OPTION

Door and enclosure kit contents:

- Door kit (c/w Trifold door)
- Half height fixed panels
- Assistance poles (1950mm) to Curtain Rail (floor to Ceiling poles available as an option - additional £15. Please confirm height requirement)
- Curtain Track and Hooks to suit door option
- White Shower Curtain
- Fitting instructions
- See p130 for Shower units (optional extra)

Shower tray contents:

- White shower tray (can be trimmed to a minimum of 1200mm on site) (coloured shower trays available in any colour to special order. A £200 charge applies. Extended delivery times apply.)
- Tray Edging Cover Strips
- Waste (only supplied with gravity shower tray)
- Fitting instructions

IMPORTANT NOTE: Trays and door kits are coded separately - for example: To order a square tray with Invawaste and Trifold enclosure - Order tray (i.e Part number IDISW10) **PLUS** door kit (i.e Part number 00-060523301).

SQUARE TRAY (NOT HANDED) To order tick the relevant circle and fax back.

1 SHOWER TRAY SIZE	2 TRAY PART NUMBER	3 LEFT HAND DOOR KIT	RIGHT HAND DOOR KIT	SPECIAL DOOR KIT
WESTDALE 1000 TRAY Price £335.20 	<input type="radio"/> IDISW10 <input type="checkbox"/> G1 c/w Invawaste <input type="radio"/> IDISW10LW <input type="checkbox"/> P1 Low waste (See p26-29 for waste pump details)	<input type="radio"/> 00-060523301 Price £479.80 	<input type="radio"/> 00-060523302 Price £479.80 	<input type="radio"/> SEE PAGE 49

PARTS

DESCRIPTION	PART NUMBER	PRICE	DESCRIPTION	PART NUMBER	PRICE
<input type="radio"/> IDATD05W	1. Door	£439.89	<input type="radio"/> IDATD06W	1. Door	£439.89
<input type="radio"/> IDASW10W	2. Jamb panel	£136	<input type="radio"/> IDASW10W	2. Jamb panel	£136
<input type="radio"/> IDASWP01W	3. Pole set	£95.40	<input type="radio"/> IDASWP02W	3. Pole set	£95.40
<input type="radio"/> IDGRL39W	4. Curtain rail	£45.33	<input type="radio"/> IDGRL39W	4. Curtain rail	£45.33
<input type="radio"/> IDGSS22	5. Curtain	£32	<input type="radio"/> IDGSS22	5. Curtain	£32

WESTDALE 1000 (LEFT HAND DOOR KIT) <p><i>Notes:</i> For shower tray part numbers see above. Invawaste & Whale pump options - see pages 23-24, 26-29</p>	WESTDALE 1000 (RIGHT HAND DOOR KIT) <p><i>Notes:</i> For shower tray part numbers see above. Invawaste & Whale pump options - see pages 23-24, 26-29</p>
-------------------------------------------------------------------------------------------------------------------------------------------------------------------------------	--------------------------------------------------------------------------------------------------------------------------------------------------------------------------------

SYMBOLS:

Bulk/oversized item



Made to order (see P192)



Tel: 0800 917 0399

www.chilterninvadex.co.uk

Fax: +44 (0) 1869 365588

sales@chilterninvadex.co.uk

CARDALE MK2 LEVEL ACCESS SHOWER

HOW TO ORDER

1 CHOOSE SHOWER TRAY SIZE

2 CHOOSE A COMBINED TRAY & DOOR KIT OPTION (this is a complete kit)

P3 Integral waste pump included as standard (& shown on p32)

Door and enclosure kit contents:



- Door kit (c/w rising butt hinge on Trifold door)
- Half height fixed panel
- Assistance pole (1830mm) to Curtain Rail (floor to Ceiling poles are available as an option - additional £15. Please confirm height requirement)
- Curtain Track and Hooks to suit door option
- White Shower Curtain
- Fitting instructions
- See p130 for Shower units (optional extra) (electric shower recommended)

Shower tray contents:

- White shower tray (coloured shower trays available in any colour to special order. A £200 charge applies. Extended delivery times apply.)
- Tray Edging Cover Strip
- Fitting instructions

IMPORTANT NOTE: Trays and door kits on this page are supplied under one code as a complete kit.

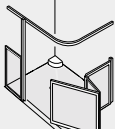
LEFT HAND TRAY To order tick the relevant circle and fax back.

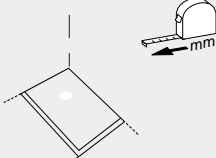
1 SHOWER TRAY SIZE		2 SHOWER TRAY/ TRIFOLD DOOR KIT	SHOWER TRAY/ TRIFOLD DOOR KIT & HALF HEIGHT PANELS	SHOWER TRAY/ TRIFOLD DOOR KIT & FULL HEIGHT PANELS	SPECIAL DOOR KIT
LEFT HAND TRAY 	Order as a P3 complete tray & door kit using part no's shown right. Waste detail shown on p32.	<input type="radio"/> IDCDLHNMK2 Price £1157 	<input type="radio"/> IDCDLHTLHP2 Price £1566 <input checked="" type="radio"/> 	<input type="radio"/> IDCDLHTLFP2 Price £1777 <input checked="" type="radio"/> 	SEE PAGE 49 

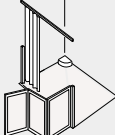
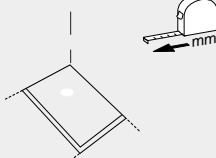
2 TRIFOLD DOOR KIT (ALCOVE INSTALLATION)			SPECIAL DOOR KIT
<input type="radio"/> IDCDALHNMK2 Price £1157 <input checked="" type="radio"/> 			SEE PAGE 49 

PARTS

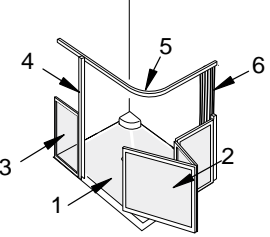
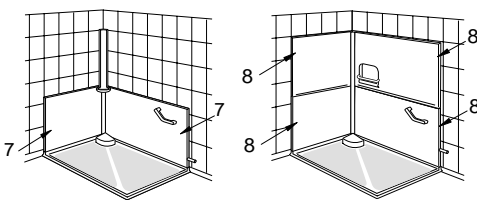
LEFT HAND CARDALE MK2 (TRIFOLD DOOR KIT)			LEFT HAND CARDALE MK2 PANELS		
 <p>Notes: For shower tray part number see below</p>					
PART NUMBER	DESCRIPTION	PRICE	PART NUMBER	DESCRIPTION	PRICE
<input type="radio"/> IDIC05	1. Tray	£351.80	<input type="radio"/> IDICP01	7. Half height wall panels	£441
<input type="radio"/> IDACTD01W	2. Door (Trifold)	£395.90	<input type="radio"/> IDICP05	8. Full height wall panels	£667.10
<input type="radio"/> IDACA01W	2. Door (alcove)	£226.10			
<input type="radio"/> IDACJ01W	3. Jamb panel	£85.78			
<input type="radio"/> IDACP01W	4. Pole set	£88.22			
<input type="radio"/> IDGRL5129W	5. Curtain rail	£38			
<input type="radio"/> IDGRS72W	5. Curtain rail (straight)	£23			
<input type="radio"/> IDGSS22	6. Curtain	£32			
<input type="radio"/> IDGSS01	6. Curtain (for straight curtain rail)	£22			

SYMBOLS:

Bulk/oversized item



Made to order (see P192)



Tel: 0800 917 0399

www.chilterninvadex.co.uk

Fax: +44 (0) 1869 365588

sales@chilterninvadex.co.uk

CARDALE MK2 LEVEL ACCESS SHOWER

HOW TO ORDER

1 CHOOSE SHOWER TRAY SIZE

2 CHOOSE A COMBINED TRAY & DOOR KIT OPTION (this is a complete kit)

P3 Integral waste pump included as standard (& shown on p32)

Door and enclosure kit contents:

- Door kit (c/w rising butt hinge on Trifold door)
- Half height fixed panel
- Assistance pole (1830mm) to Curtain Rail (floor to Ceiling poles are available as an option - additional £15. Please confirm height requirement)
- Curtain Track and Hooks to suit door option
- White Shower Curtain
- Fitting instructions
- See p130 for Shower units (optional extra) (electric shower recommended)

Shower tray contents:

- White shower tray (coloured shower trays available in any colour to special order. A £200 charge applies. Extended delivery times apply.)
- Tray Edging Cover Strip
- Fitting instructions

IMPORTANT NOTE: Trays and door kits on this page are supplied under one code as a complete kit.

RIGHT HAND TRAY To order tick the relevant circle and fax back.

1 SHOWER TRAY SIZE		2 SHOWER TRAY/ TRIFOLD DOOR KIT	SHOWER TRAY/ TRIFOLD DOOR KIT & HALF HEIGHT PANELS	SHOWER TRAY/ TRIFOLD DOOR KIT & FULL HEIGHT PANELS	SHOWER TRAY/ SPECIAL DOOR KIT
RIGHT HAND TRAY 	Order as a complete tray & door kit using part no's shown right. Waste detail shown on p32. P3	<input type="radio"/> IDCDRHNMK2 Price £1157 	<input type="radio"/> IDCDRHTLHP2 Price £1566 <input type="checkbox"/>  	<input type="radio"/> IDCDRHTLFP2 Price £1777 <input type="checkbox"/>  	SEE PAGE 49  ALCOVE POSSIBLE

2 TRIFOLD DOOR KIT (ALCOVE INSTALLATION)	SPECIAL DOOR KIT		
<input type="radio"/> IDCDARHNMK2 Price £1157 <input type="checkbox"/>  			SEE PAGE 49 

PARTS

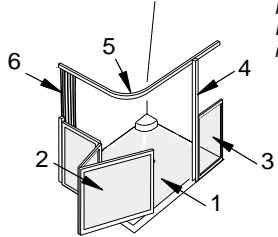
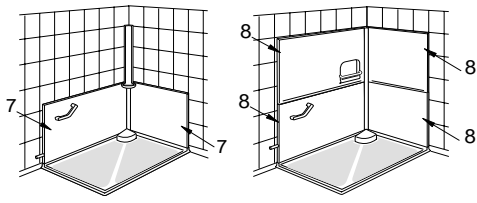
RIGHT HAND CARDALE MK2 (TRIFOLD DOOR KIT)			RIGHT HAND CARDALE MK2 PANELS		
		Notes: For shower tray part number see below			
PART NUMBER	DESCRIPTION	PRICE	PART NUMBER	DESCRIPTION	PRICE
<input type="radio"/> IDIC07	1. Tray	£351.80	<input type="radio"/> IDICP03	7. Half height wall panels	£441
<input type="radio"/> IDACTD02W	2. Door (Trifold)	£395.90	<input type="radio"/> IDICP07	8. Full height wall panels	£667.10
<input type="radio"/> IDACA02W	2. Door (alcove)	£226.10			
<input type="radio"/> IDACJ02W	3. Jamb panel	£85.78			
<input type="radio"/> IDACP02W	4. Pole set	£88.22			
<input type="radio"/> IDGRL5129W	5. Curtain rail	£38			
<input type="radio"/> IDGRS72W	5. Curtain rail (straight)	£23			
<input type="radio"/> IDGSS22	6. Curtain	£32			
<input type="radio"/> IDGSS01	6. Curtain (for straight curtain rail)	£22			

SYMBOLS:

Bulk/oversized item 

Made to order (see P192) 

Tel: 0800 917 0399

www.chilterninvadex.co.uk

Fax: +44 (0) 1869 365588

sales@chilterninvadex.co.uk