

SHOWER TRAY SELECTOR - LEVEL ACCESS SHOWER TRAYS

Use this shower tray selector to choose the handing and tray size required. The key at the foot of the page explains the symbols used throughout this section.

SANDWELL MK3 655 SANDWELL MK3 760		SANDWELL MK3 655 SANDWELL MK3 760	
G1 P1 P2*	 <i>*Shower Waste Pump option suitable for timber joist situation with typical void - see p30-31.</i>	G1 P1 P2*	 <i>*Shower Waste Pump option suitable for timber joist situation with void - see p30-31.</i>
LEFT HAND		RIGHT HAND	
WESTDALE 655 WESTDALE 760		WESTDALE 655 WESTDALE 760	
G1 P1 P2*	 <i>*Shower Waste Pump option suitable for timber joist situation with void - see p30-31.</i>	G1 P1 P2*	 <i>*Shower Waste Pump option suitable for timber joist situation with void - see p30-31.</i>
LEFT HAND		RIGHT HAND	
WESTDALE 850		WESTDALE 850	
G1 P1 P2*	 <i>*Shower Waste Pump option suitable for timber joist situation with void - see p30-31.</i>	G1 P1 P2*	 <i>*Shower Waste Pump option suitable for timber joist situation with void - see p30-31.</i>
LEFT HAND		RIGHT HAND	
WESTDALE 1000			
G1 NOT HANDED P1 P2*	 Rotate to suit	<i>*Shower Waste Pump option suitable for timber joist situation with void - see p30-31.</i>	
CARDALE MK2		CARDALE MK2	
P3		LEFT HAND	
LEFT HAND		RIGHT HAND	
GRAVITY WASTE OPTIONS		PUMPED WASTE OPTIONS	
Gravity waste (Invawaste) G1 See pages 23-24 for comprehensive details		Whale Shower Drain Pump Kit P1 See pages 26-29 for comprehensive details	
KEY		Shower Waste Pump P2 <i>NOT suitable for below tray drainage on concrete floors</i> See page 30-31 for comprehensive details	
		Shower tray Integral Pump P3 See page 32 for comprehensive details	

SYMBOLS:

Bulk/oversized item

Made to order (see P192)

Tel: 0800 917 0399









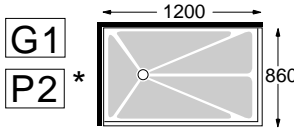
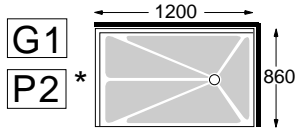

www.chilterninvadex.co.uk

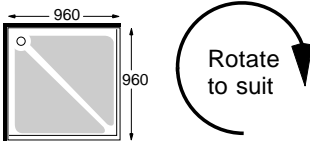

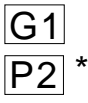
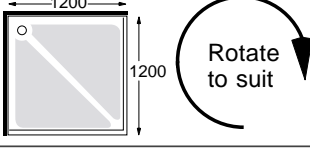
Fax: +44 (0) 1869 365588

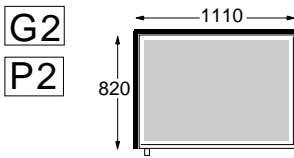
sales@chilterninvadex.co.uk

SHOWER TRAY SELECTOR - EASY ACCESS SHOWER TRAYS

Use this shower tray selector to choose the handing and tray size required. The key at the foot of the page explains the symbols used throughout this section.

ABBEYDALE 760  LEFT HAND <i>*Shower Waste Pump option suitable for timber joist situation with void - see p30-31.</i>		ABBEYDALE 760  RIGHT HAND <i>*Shower Waste Pump option suitable for timber joist situation with void - see p30-31.</i>	
ABBEYDALE 850  NOT HANDED  <i>*Shower Waste Pump option suitable for timber joist situation with void - see p30-31.</i>			
ABBEYDALE 950  NOT HANDED  <i>*Shower Waste Pump option suitable for timber joist situation with void - see p30-31.</i>			
ABBEYDALE 1050  NOT HANDED  <i>*Shower Waste Pump option suitable for timber joist situation with void - see p30-31.</i>			
DOVEDALE MK2  4-WAY HAND <i>Notes: Trap not included. A P/S trap is suggested. Outlet diameter is 40mm.</i>			
EDALE MK2  LEFT HAND <i>Notes: Trap not included. A P/S trap is suggested. Outlet diameter is 40mm.</i>		 RIGHT HAND <i>Notes: Trap not included. A P/S trap is suggested. Outlet diameter is 40mm.</i>	
GRAVITY WASTE OPTIONS Gravity waste (Invawaste) G1 See pages 23-24 for comprehensive details  Above floor waste outlet G2 See page 25 for comprehensive details 		PUMPED WASTE OPTIONS Shower Waste Pump (box kit) P2 <i>NOT suitable for below tray drainage on concrete floors</i> See pages 30-31 for comprehensive details  <h1>KEY</h1>	

SYMBOLS:
 Bulk/oversized item 
 Made to order (see P192) 





Tel: 0800 917 0399
 www.chilterninvadex.co.uk

Fax: +44 (0) 1869 365588
 sales@chilterninvadex.co.uk

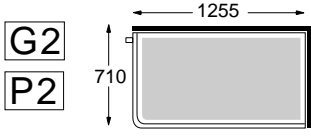
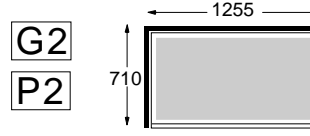
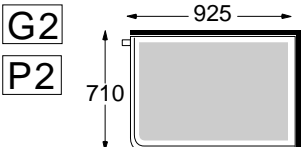
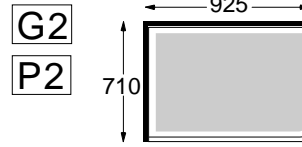
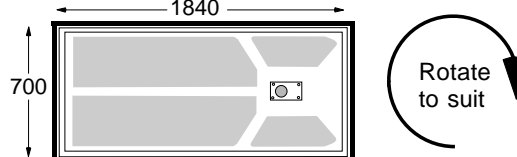
SHOWER TRAY SELECTOR - STEP-IN SHOWER TRAYS

Use this shower tray selector to choose the handing and tray size required. The key at the foot of the page explains the symbols used throughout this section.

BERRIEDALE		BERRIEDALE	
 <p>LEFT HAND</p>	 <p>RIGHT HAND</p>		
FERNDALE		FERNDALE	
 <p>LEFT HAND</p>	 <p>RIGHT HAND</p>		
HENLEYDALE			
<p>The Henleydale has a gravity waste, routable underneath the tray for convenience in installation See page 48.</p>			<p>NOT HANDED</p>

GRAVITY WASTE OPTIONS		PUMPED WASTE OPTIONS	
<p>Above floor waste outlet </p> <p>See page 25 for comprehensive details</p> 	<p>Shower Waste Pump </p> <p><i>NOT suitable for below tray drainage on concrete floors</i></p> <p>See page 30-31 for comprehensive details</p> 		
KEY			

SYMBOLS:

Bulk/oversized item 

Made to order (see P192) 

Tel: 0800 917 0399

www.chilterninvadex.co.uk

Fax: +44 (0) 1869 365588

sales@chilterninvadex.co.uk

GRAVITY WASTE (INVAWASTE)

G1

See p20-21 for Tray options



Gravity waste (Invawaste) suitable for timber floor construction

- Designed for use on a timber floor installation - sits within void in joists. 90mm shower trap with removable waste.
- For use with the following shower trays (gravity versions):
 - Sandwell range (Included in standard package)
 - Westdale range (Included in standard package)
 - Abbeydale range (Included in standard package)
- Removable top cover and removable inner cup for routine cleaning and maintenance

For further technical information go to the Shower trays & enclosure specification guide. This section starts on page 33.

code	product	Price
IDMIV02	Gravity waste (chrome) - replacement part	£28.22

GRAVITY WASTE DETAILS

Gravity waste (Invawaste) exploded view

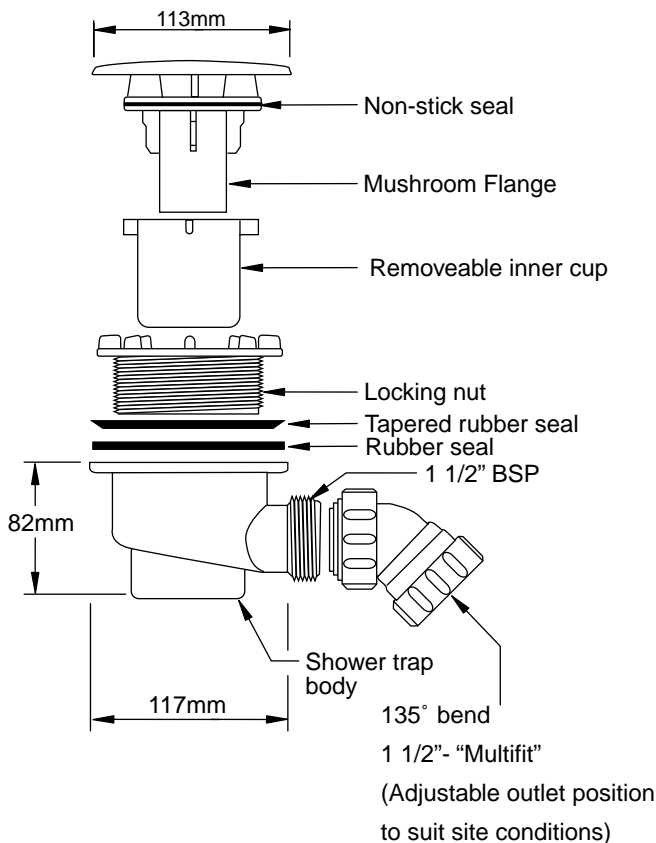

Gravity waste (Invawaste) plan view

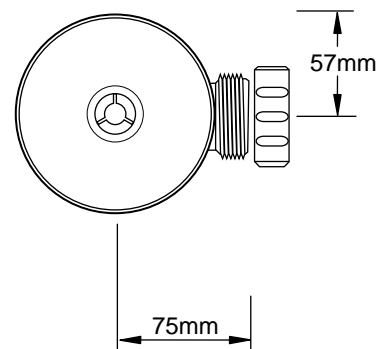

Gravity waste (Invawaste) cross section assembled

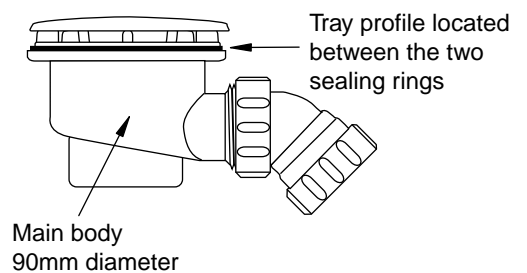

SYMBOLS:

Bulk/oversized item



Made to order (see P192)



Tel: 0800 917 0399

www.chilterninvadex.co.uk

Fax: +44 (0) 1869 365588

sales@chilterninvadex.co.uk

GRAVITY WASTE (INVAWASTE)

G1

See p20-21 for Tray options

TYPICAL CROSS SECTION THROUGH LEVEL ACCESS SHOWER TRAY - TIMBER FLOOR CONSTRUCTION

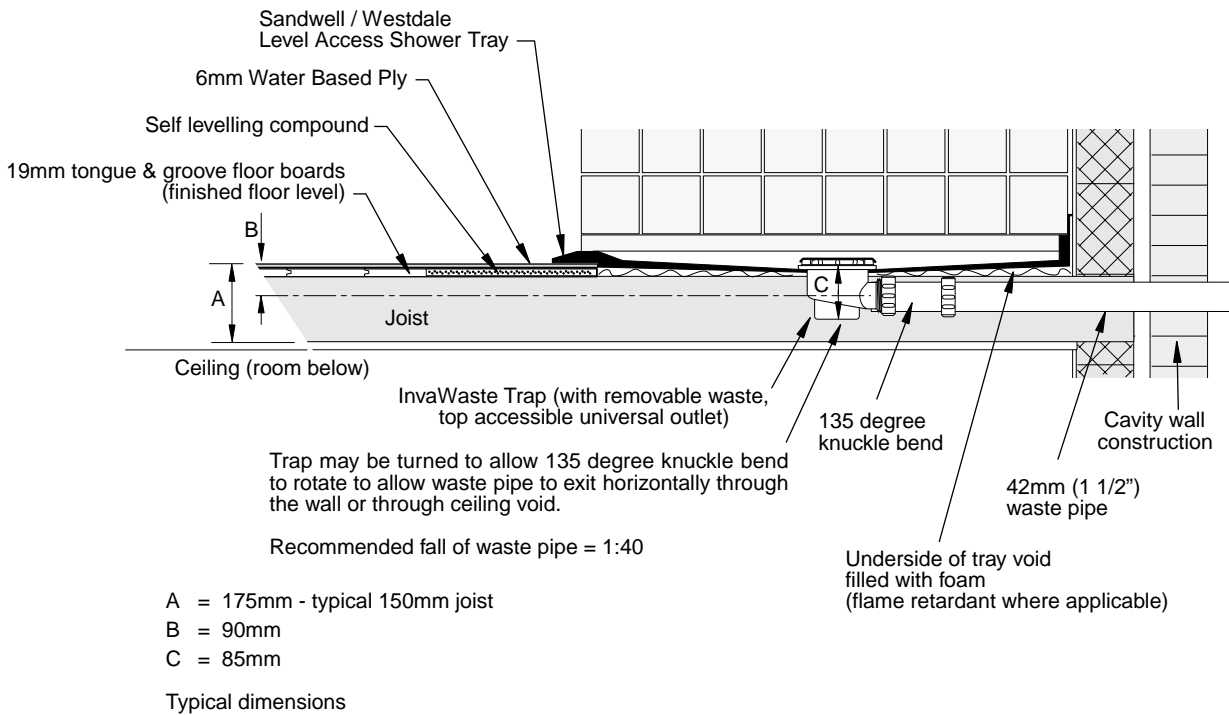

TYPICAL 3D SECTION THROUGH LEVEL ACCESS SHOWER TRAY - TIMBER FLOOR CONSTRUCTION

Example Illustration shows Westdale 655/760 shower tray installation (left hand waste outlet)
 Note position of waste over to left hand side

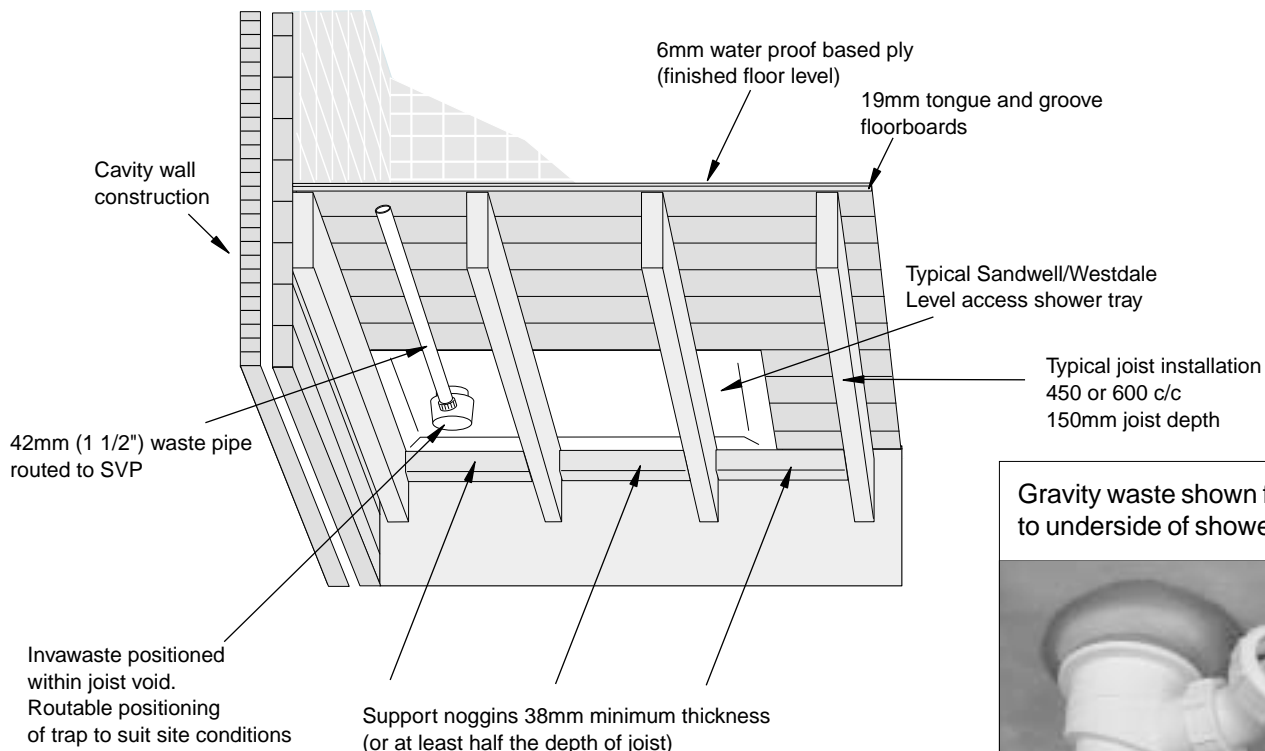

Gravity waste shown fitted to underside of shower tray



SYMBOLS:

Bulk/oversized item



Made to order (see P192)



Tel: 0800 917 0399

www.chilterninvadex.co.uk

Fax: +44 (0) 1869 365588

sales@chilterninvadex.co.uk

SHOWER TRAY - ABOVE FLOOR WASTE OUTLET

G2

See p20-21 for
Tray options



Edale MK2 pictured

Above floor waste outlet

- Above floor waste - no need to remove the floor as waste water discharge is above floor
- Left or right hand
- To be used in conjunction with a P/S trap

For further technical information go to the Shower trays & enclosure specification guide. See pages 40, 45-47.

Technical Information

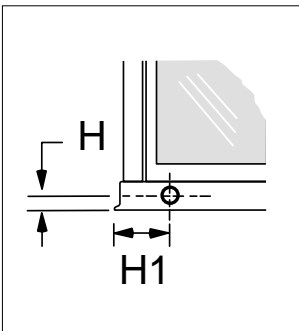

- Pipe diameter 1 1/2" (40mm)
- Projection 45mm for coupling up

H=40mm
H1=80mm

Outlet pipe height to centreline

SYMBOLS:

Bulk/oversized item



Made to order (see P192)



Tel: 0800 917 0399

www.chilterninvadex.co.uk

Fax: +44 (0) 1869 365588

sales@chilterninvadex.co.uk

PUMPED WASTE

P1

See p20 for
Tray options



Pumped waste suitable for concrete floor construction

- Designed for use on a concrete floor installation
- Ideal application when a shower tray installation is required and it is not possible to utilise a gravity version due to the depth of a typical gravity trap. The Whale waste outlet and pipework can be sited into the screed requiring only a 45mm depth, therefore unaffacting a typical in-situ RC suspended floor and/or pre-cast concrete floor.
- For use with the following level access shower trays (pumped versions - low waste trays):
 - Sandwell range
 - Westdale range
- Can pump hair, gel, grit and other shower waste without blocking
- No filter in waste system - no cleaning required
- Valves integral to the pump prevent odours escaping from the drainage pipe
- Please contact the Technical Helpdesk for additional technical information

code	product	Price
IDWWP01	Whale automatic tray gully kit	£312
IDWWP03	Whale pump mixer conversion kit (Flow switch & 'Y' filter) required for shower mixer valve installation	£33.40

WASTE GULLEY DETAILS

For further technical information go to the Shower trays & enclosure specification guide. This section starts on page 33.

Waste Gully exploded view

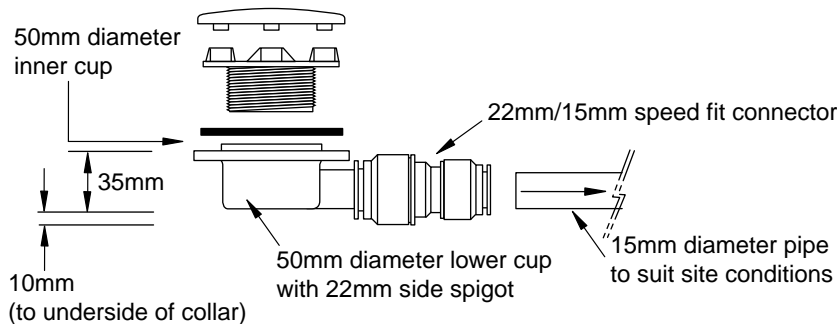

Important:

Dimension of 45mm (to underside of tray to be excavated to house waste collar)

Waste Gully Plan view

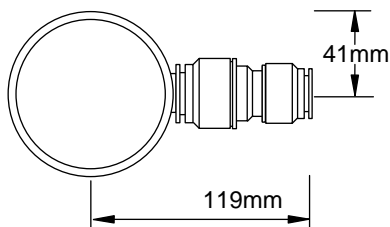

Waste Gully Cross section assembled

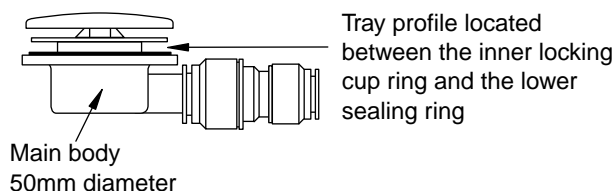

SYMBOLS:

Bulk/oversized item



Made to order (see P192)



Tel: 0800 917 0399

www.chilterninvadex.co.uk

Fax: +44 (0) 1869 365588

sales@chilterninvadex.co.uk

PUMPED WASTE

P1

See p20 for Tray options

TYPICAL CROSS SECTION THROUGH LEVEL ACCESS SHOWER TRAY - CONCRETE FLOOR CONSTRUCTION

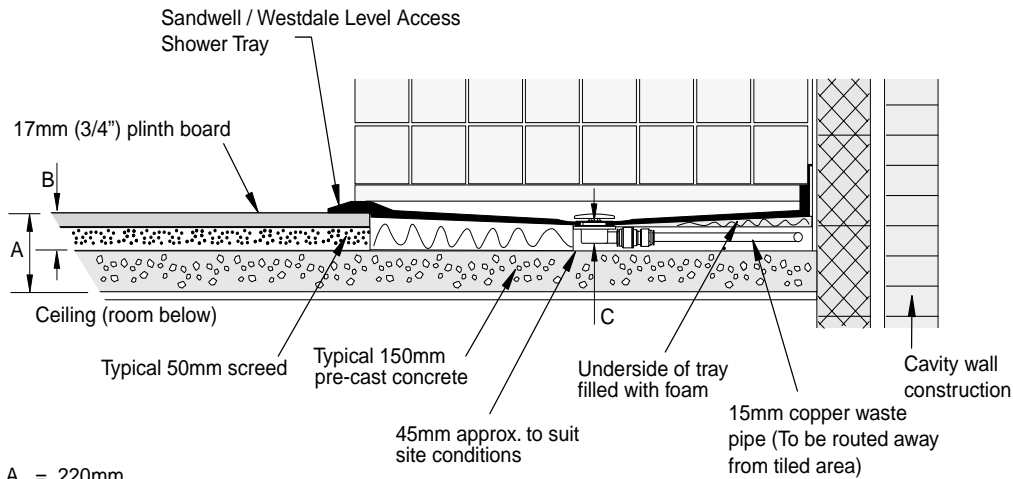

A = 220mm

B = 70mm

C = 35mm (45mm to underside of main collar attachment)

NOTE. When installing use silicone on top of seal when positioning beneath the tray to ensure correct sealing.

(Typical dimensions)

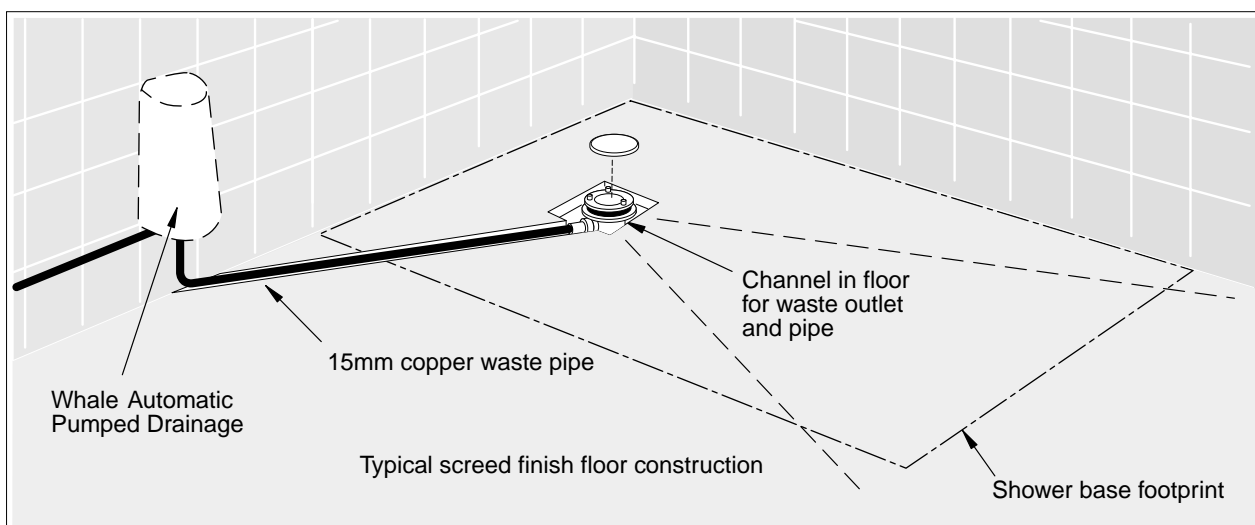
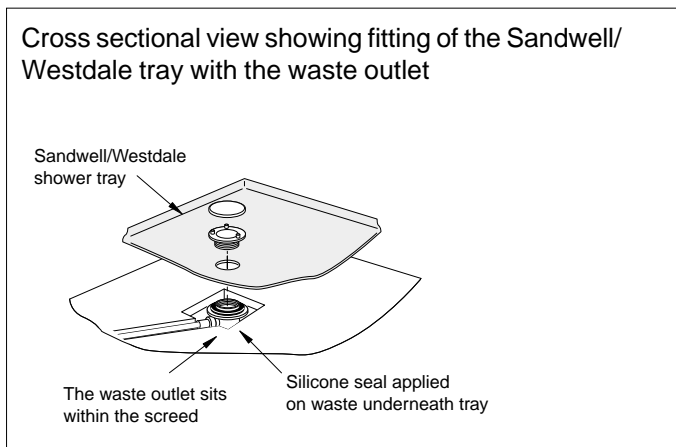

Notes:

Dashed lines indicate alternate routes (these may vary other than those shown, dependent on site conditions)

Tray to be recessed into the finished screed level - 20mm depth

(Full installation instructions available at www.chilterninvadex.co.uk or by contacting the Technical Department)

SYMBOLS:

Bulk/oversized item



Made to order (see P192)



Tel: 0800 917 0399

www.chilterninvadex.co.uk

Fax: +44 (0) 1869 365588

sales@chilterninvadex.co.uk

PUMPED WASTE

P1

See p20 for Tray options

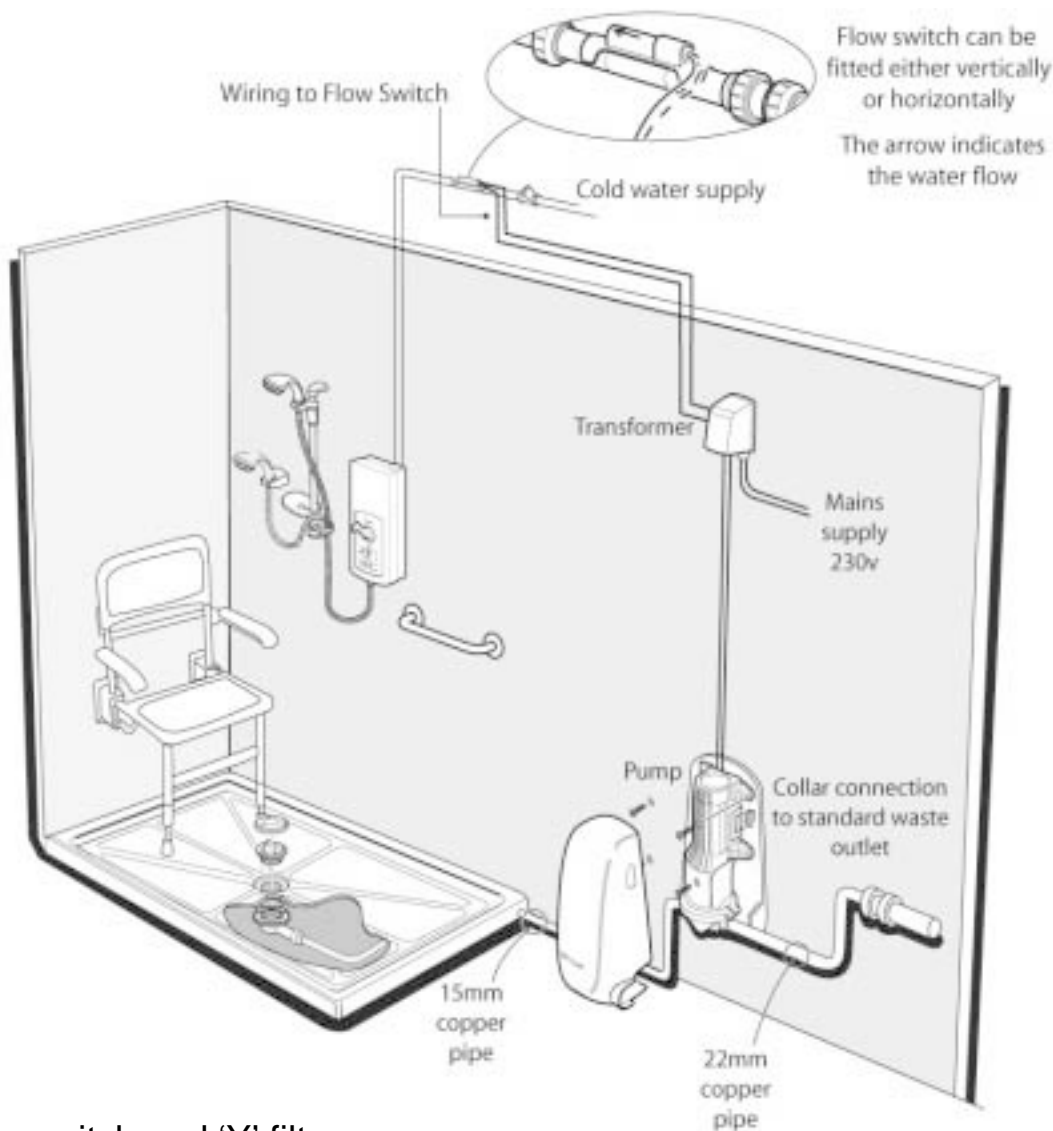

Flow switch and 'Y' filter

code	product	Price
IDWWP03	Whale pump mixer conversion kit (Flow switch & 'Y' filter) required for shower mixer valve installation	£33.40

Important:

An additional flow switch is required for a shower mixer valve installation connected into the hot water supply.

The switch may be positioned horizontally or vertically.

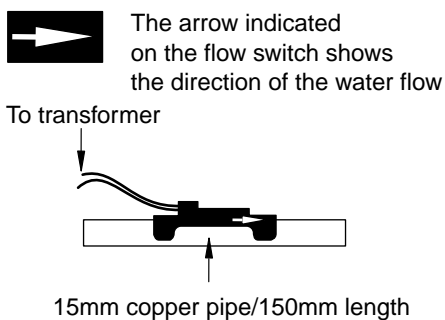

SYMBOLS:

Bulk/oversized item



Made to order (see P192)



Tel: 0800 917 0399

www.chilterninvadex.co.uk

Fax: +44 (0) 1869 365588

sales@chilterninvadex.co.uk

PUMPED WASTE

P1

See p20 for
Tray options



Digital smoothflow upgrade kit (upgrade to pump shown on p26)

- Almost silent when running - eliminates gulley suction noise
- Suits any existing Whale installation
- Flow rate of the pump adjusts automatically to changes in the shower flow rate
- Compensates for changes in the voltage from the mains electric supply
- 2 year warranty

code	product	Price
IDWWP06	Digital smoothflow upgrade kit	£350

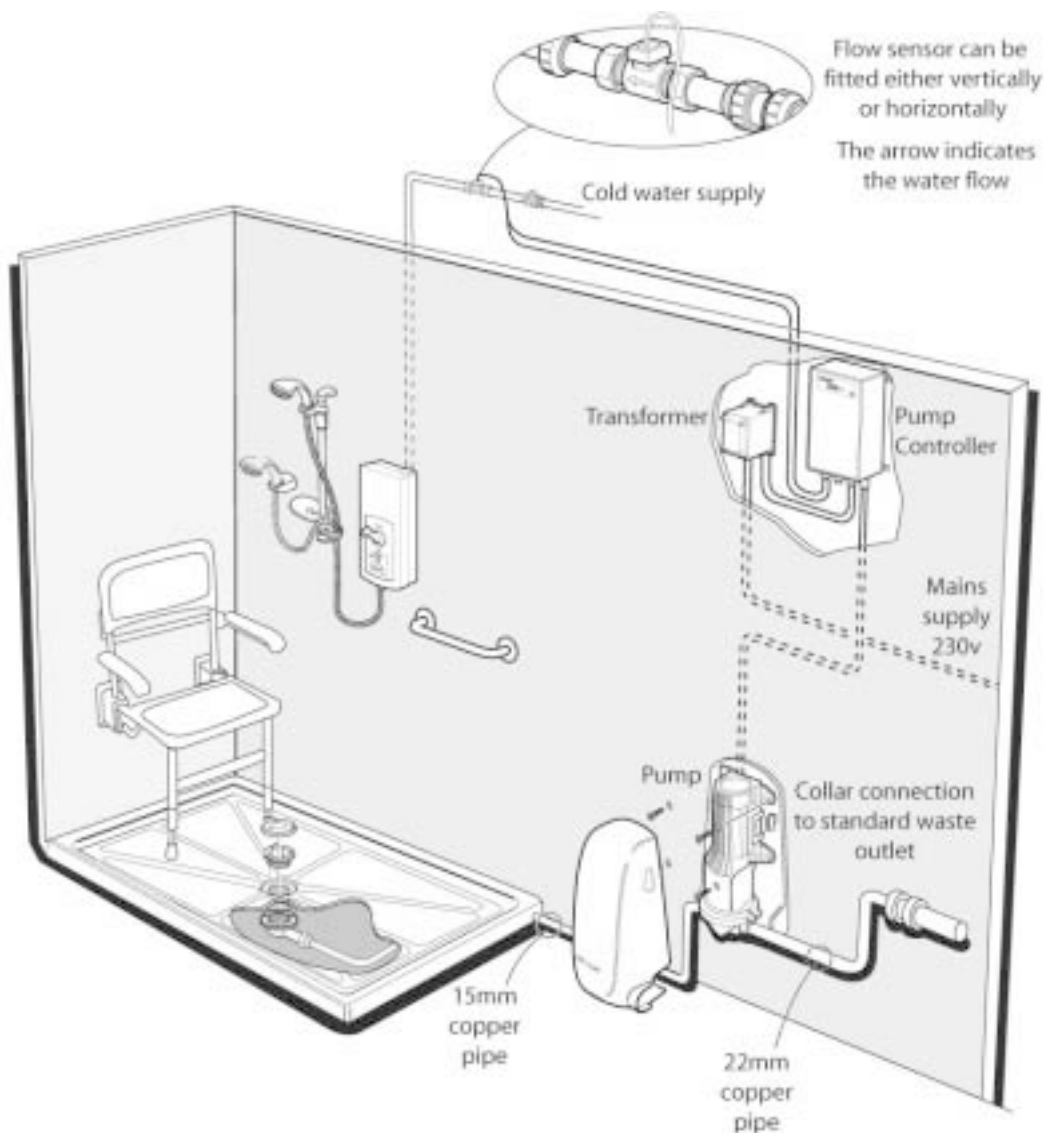

SYMBOLS:

Bulk/oversized item



Made to order (see P192)



Tel: 0800 917 0399

www.chilterninvadex.co.uk

Fax: +44 (0) 1869 365588

sales@chilterninvadex.co.uk

SHOWER WASTE PUMP

P2

See p20-22
for Tray options



Kit illustrated

Shower waste pump kit

- Where access to drainage is difficult a shower waste pump allows waste water to be pumped away, without the need to rely on a gravity fall
- Suits all Chiltern Invadex shower trays (except Cardale which comes with its own pump) as shown below
- Quiet and filterless low voltage pump (12v)
- Simple to install and maintain
- Audible alarm to indicate blockages
- Pump lid snaps on and is easily removed for routine cleaning and maintenance

Shower waste pump kit compatibility selector



Shown recessed



Shown surface mounted

	TRAY DESCRIPTION	TYPICAL TIMBER FLOOR CONSTRUCTION	TYPICAL CONCRETE/SCREED FLOOR CONSTRUCTION
LEVEL ACCESS	Sandwell MK3 655	✓	×
	Sandwell MK3 760	✓	×
	Westdale 655	✓	×
	Westdale 760	✓	×
	Westdale 850	✓	×
	Westdale 1000	✓	×
	Cardale MK2	Supplied with integral pump	Supplied with integral pump
EASY ACCESS	Abbeydale 760	✓	×
	Abbeydale 850	✓	×
	Abbeydale 950	✓	×
	Abbeydale 1050	✓	×
	Dovedale MK2	✓	✓
	Edale MK2	✓	✓
STEP-IN	Berriedale	✓	✓
	Ferndale	✓	✓

code	product	Price
115-00001	Standard Pump Kit, single unit	£347
115-00001	Standard Pump Kit, box of 5 units	each £332
115-00001	Standard Pump Kit, box of 10+ units	each £313

Package includes wiring block - which controls the pump manually, pump and necessary fittings & connections to the above floor outlet or Invawaste - see pages 23-24.

Technical Information

Notes: Flexi-pipe supplied (40mm) for flow into box. Flow outlet from box is 22mm

Maximum 15 litres/min drainage (dependent on type of shower tray)

Case constructed from white flame retardant ABS

Side and end elevation

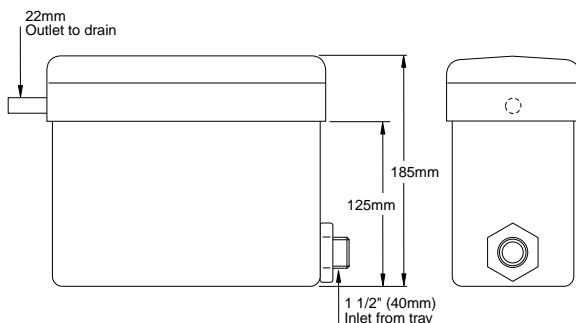

Plan elevation

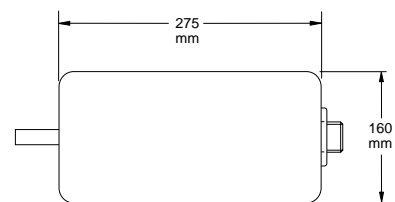

SYMBOLS:

Bulk/oversized item



Made to order (see P192)



Tel: 0800 917 0399

www.chilterninvadex.co.uk

Fax: +44 (0) 1869 365588

sales@chilterninvadex.co.uk

SHOWER WASTE PUMP

P2

See p20-22
for Tray options

Technical Information

For further technical information go to the Shower trays & enclosure specification guide. This section starts on page 33.

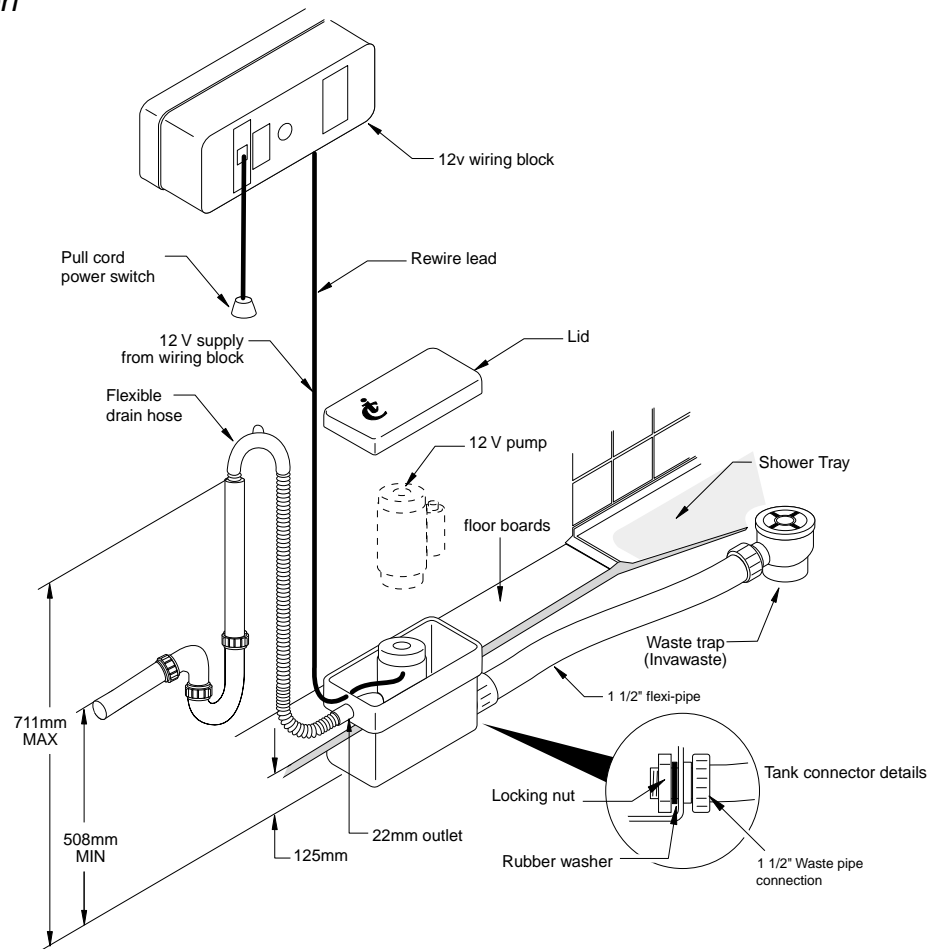

Notes:

Typical stack detail, waste hose running into standpipe with P-trap. Waste pipe laid is suitable gradient before running into hopper head, gully or SVP.

Please note:

Chiltern Invadex can supply an automatic version of the Shower Waste Pump kit shown above. Please contact the Technical Helpdesk for assistance.

Typical installation utilising washing machine type waste

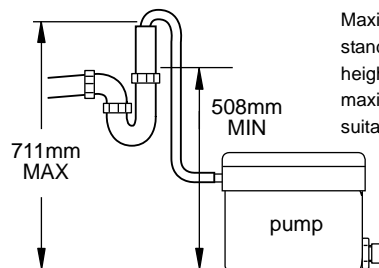

Maximum height from base of box to top of standpipe 711mm (28") down to a minimum height of waste discharge 508mm (20") will give maximum efficiency of the pump, with a suitable down gradient slope.

SYMBOLS:

Bulk/oversized item



Made to order (see P192)



Tel: 0800 917 0399

www.chilterninvadex.co.uk

Fax: +44 (0) 1869 365588

sales@chilterninvadex.co.uk

SHOWER TRAY INTEGRAL WASTE PUMP

P3

See p20 for
Cardale MK2
Tray options



Shower tray Integral waste pump (Included as standard on Cardale MK2)

- Where access to drainage is difficult a Shower tray Integral waste pump allows waste water to be pumped away, without the need to rely on a gravity fall
- Supplied complete with cover, easily removed for routine cleaning and maintenance
- Quiet and filterless low voltage pump (12v)
- Simple to install and maintain
- Audible alarm to indicate blockages
- Stud wall minimum width - typically 75mm minimum to house 40mm stack pipe.



- Cardale MK2 shown left with 12v wiring block, integral pump, rewire lead and cover

For further technical information go to the Shower trays & enclosure specification guide (page 39)

Technical Information

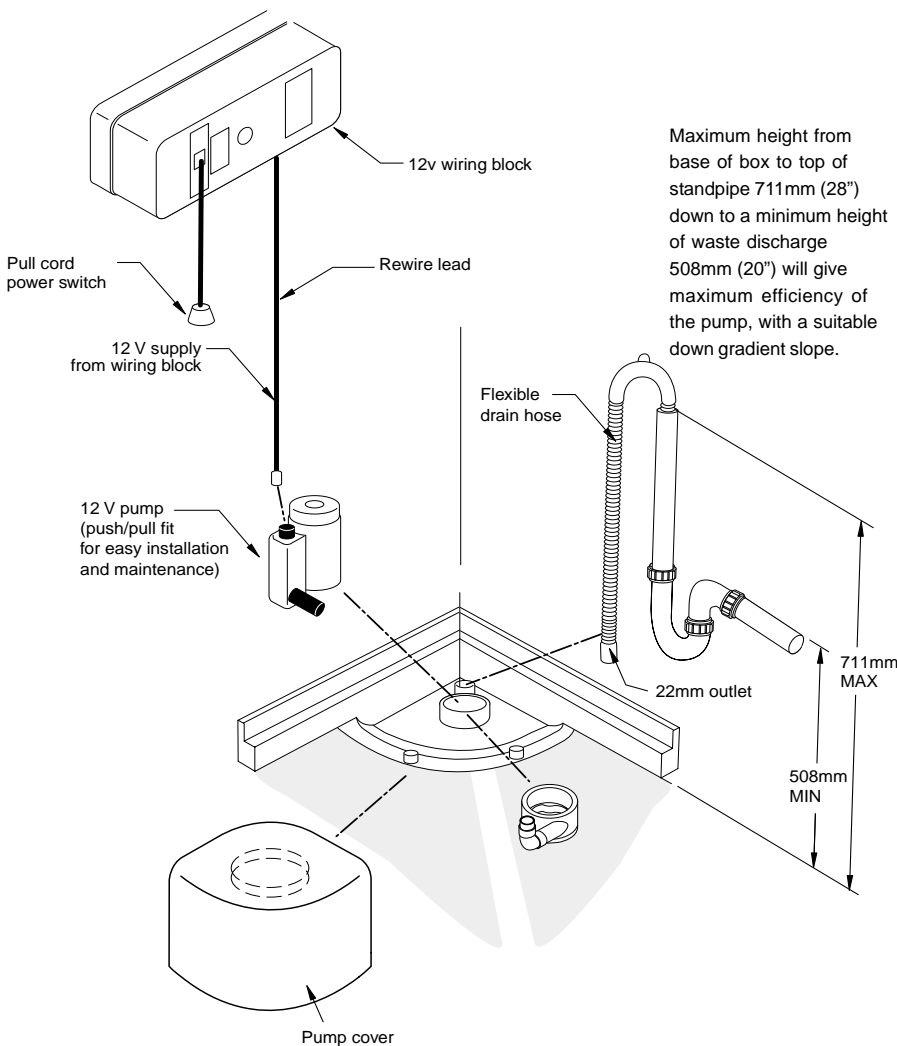

Typical installation utilising washing machine type waste

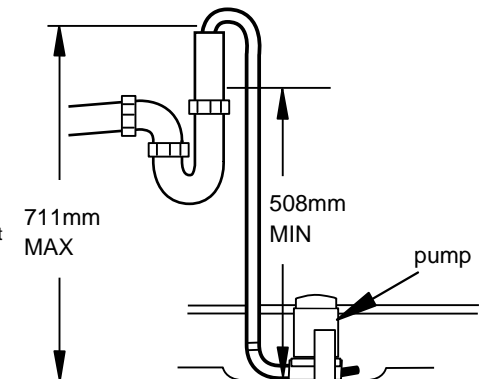

Notes:

Typical stack detail, waste hose running into standpipe with P-trap. Waste pipe laid to suitable gradient before running into hopper head, gully or SVP.

SYMBOLS:

Bulk/oversized item



Made to order (see P192)



Tel: 0800 917 0399

www.chilterninvadex.co.uk

Fax: +44 (0) 1869 365588

sales@chilterninvadex.co.uk