



**SHOWER CUBICLE TOILET RANGE**

# FRONT ENTRY SHOWER CUBICLE TOILET 100MK2

Cubicle kit contents:

- White Shower Tray
- Full height enclosure pack
- Door set - half height (not handed) or tri-fold (left or right hand) doors
- Curtain Track and Hooks (to suit door option)
- White Shower Curtain
- Detachable ramp
- Grab rails
- Shower unit options shown on p130 (not included in package price)
- Fitting instructions

## HOW TO ORDER



	Option 1	Option 2	Option 3
<b>Cubicle description</b>	<b>Half height door</b>	<b>Trifold (Left hand)</b>	<b>Trifold (Right hand)</b>
100MK2 Cubicle Toilet with pumped waste	Part no: SHTCU100PW Price: £2165.00	Part no: SHTCU100PW Price: £2165.00	Part no: SHTCU100PW Price: £2165.00
100MK2 Cubicle Toilet with gravity waste	Part no: SHTCU100G Price: £1945.00	Part no: SHTCU100G Price: £1945.00	Part no: SHTCU100G Price: £1945.00

## Technical information

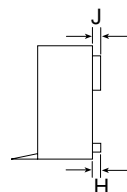
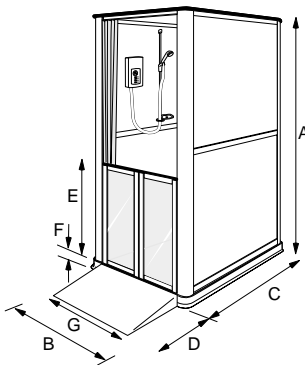

Ramp size:  
780mm x 200mm  
\*Add 100mm if side controls fitted.  
+Add 75mm if basin fitted.  
H=outlet pipe at rear of cubicle  
J=cistern

Ref	Dimensions
A	2015
B	960* +
C	1037
D	200
E	810
F	45
G	780
H	50
J	200

### Model 100MK2 (Standard doors)

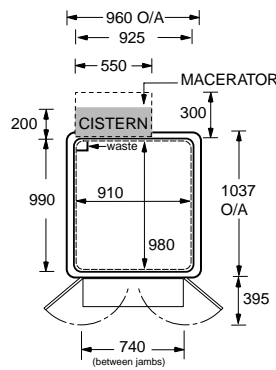

### Model 100MK2 (Tri-fold doors)

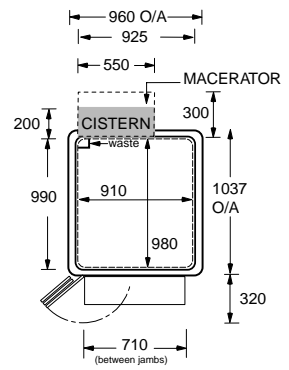

### Shower chair compatibility

See page 95 for shower chair compatibility options

**Notes:** Dimensions are for doors fully open.

**Internal dimensions:** The width is measured from acrylic panel to acrylic panel. The depth is taken from the back acrylic panel to the inner face of the door.

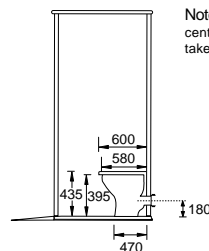

**Note:** centreline of waste (left) is taken from top of cubicle base

Chiltern Invadex shower cubicles are available with a large range of options and accessories, allowing the cubicle to be configured to suit specific client requirements. A quick order form is available to help select the appropriate options. Please contact Customer Service for details or to arrange a visit by a Technical Sales Representative.

### SYMBOLS:

Bulk/oversized item



Made to order (see P192)



Tel: 0800 917 0399

www.chilterninvadex.co.uk

Fax: +44 (0) 1869 365588

sales@chilterninvadex.co.uk

# FRONT ENTRY MODEL 75 SHOWER CUBICLE TOILET

Cubicle kit contents:

- White Shower Tray with fixed ramp
- Enclosure pack
- Door set - half height (not handed) or tri-fold (left or right hand) doors
- Curtain Track and Hooks (to suit door option)
- White Shower Curtain
- Grab rails
- Shower unit options shown on p130 (not included in package price)
- Fitting instructions

## HOW TO ORDER



	Option 1	Option 2	Option 3
<b>Cubicle description</b>	<b>Half height door</b>	<b>Trifold (Left hand)</b>	<b>Trifold (Right hand)</b>
75 Cubicle with pumped waste	Part no: SHTCU75PW Price: £2165.00	Part no: SHTCU75PW Price: £2165.00	Part no: SHTCU75PW Price: £2165.00
75 with gravity waste	Part no: SHTCU75G Price: £1945.00	Part no: SHTCU75G Price: £1945.00	Part no: SHTCU75G Price: £1945.00

## Technical information

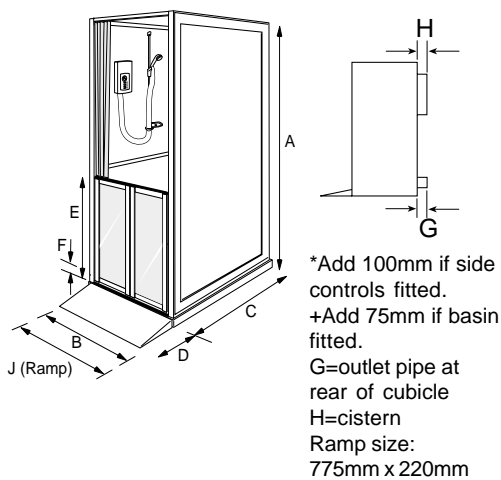

Ref	Dimensions
A	1900
B	780*
C	930
D	215
E	810
F	70
G	50
H	200
J	775

### Model 75 (Standard doors)

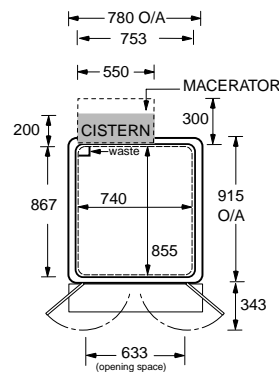

### Model 75 (Tri-fold doors)

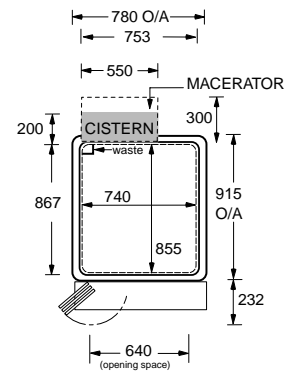

### Shower chair compatibility

See page 95 for shower chair compatibility options

**Note:** Dimensions are for doors fully open.

**Internal dimensions:** The width is measured from acrylic panel to acrylic panel. The depth is taken from the back acrylic panel to the inner face of the door.

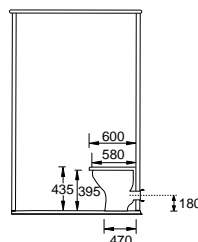

**Note:**  
centreline of waste (left) is taken from top of cubicle base

Chiltern Invadex shower cubicles are available with a large range of options and accessories, allowing the cubicle to be configured to suit specific client requirements. A quick order form is available to help select the appropriate options. Please contact Customer Service for details or to arrange a visit by a Technical Sales Representative.

### SYMBOLS:

Bulk/oversized item



Made to order (see P192)



Tel: 0800 917 0399

www.chilterninvadex.co.uk

Fax: +44 (0) 1869 365588

sales@chilterninvadex.co.uk

# FRONT ENTRY MODEL 101 SHOWER CUBICLE TOILET

**Cubicle kit contents:**

- White Shower Tray
- Full height enclosure pack
- Door set - half height (not handed) or tri-fold (left or right hand) doors
- Curtain Track and Hooks (to suit door option)
- White Shower Curtain
- Fixed ramp
- Grab rails
- Shower unit options shown on p130 (not included in package price)
- Fitting instructions

## HOW TO ORDER



	Option 1	Option 2	Option 3
<b>Cubicle description</b>	<b>Half height door</b>	<b>Trifold (Left hand)</b>	<b>Trifold (Right hand)</b>
101 Cubicle Toilet with pumped waste	Part no: SHTCU101PW Price: £2165	Part no: SHTCU101PW Price: £2165	Part no: SHTCU101PW Price: £2165
101 Cubicle Toilet with gravity waste	Part no: SHTCU101G Price: £1945	Part no: SHTCU101G Price: £1945	Part no: SHTCU101G Price: £1945

## Technical information

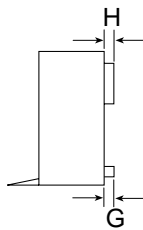
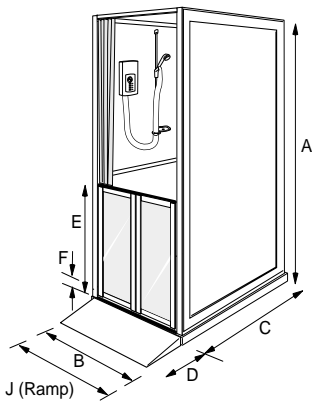

\*Add 100mm if side controls fitted.  
+Add 75mm if basin fitted.  
G=outlet pipe at rear of cubicle  
H=cistern  
Ramp size:  
1000mm x 430mm

Ref	Dimensions
A	1900
B	1010*+
C	1030
D	430
E	810
F	70
G	50
H	200
J	1000

### Model 101 Toilet (Standard doors)

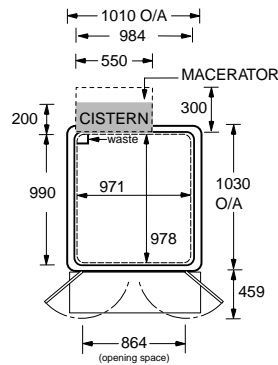

### Model 101 Toilet (Tri-fold doors)

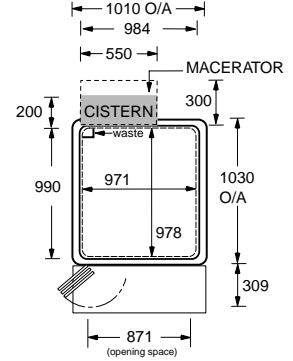

### Shower chair compatibility

See page 95 for shower chair compatibility options

**Note:** Dimensions are for doors fully open.

**Internal dimensions:** The width is measured from acrylic panel to acrylic panel.

The depth is taken from the back acrylic panel to the inner face of the door.

\*Note: Macerators should be fitted by suitably qualified personnel

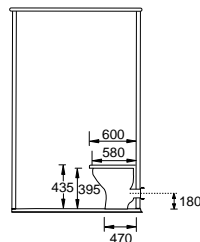

**Note:**  
centreline of waste (left) is taken from top of cubicle base

Chiltern Invadex shower cubicles are available with a large range of options and accessories, allowing the cubicle to be configured to suit specific client requirements. A quick order form is available to help select the appropriate options. Please contact Customer Service for details or to arrange a visit by a Technical Sales Representative.

### SYMBOLS:

Bulk/oversized item



Made to order (see P192)



Tel: 0800 917 0399

www.chilterninvadex.co.uk

Fax: +44 (0) 1869 365588

sales@chilterninvadex.co.uk

# FRONT ENTRY MODEL 120 SHOWER CUBICLE TOILET

## Cubicle kit contents:

- White Shower Tray
- Full height enclosure pack
- Door set - half height (not handed) or tri-fold (left or right hand) doors
- Curtain Track and Hooks (to suit door option)
- White Shower Curtain
- Fixed ramp
- Grab rails
- Shower unit options shown on p130 (not included in package price)
- Fitting instructions

## HOW TO ORDER



	Option 1	Option 2	Option 3
<b>Cubicle description</b>	<b>Half height door</b>	<b>Trifold (Left hand)</b>	<b>Trifold (Right hand)</b>
120 Cubicle Toilet with pumped waste	Part no: SHTCU120PW Price: £2285	Part no: SHTCU120PW Price: £2285	Part no: SHTCU120PW Price: £2285
120 Cubicle Toilet with gravity waste	Part no: SHTCU120G Price: £2058	Part no: SHTCU120G Price: £2058	Part no: SHTCU120G Price: £2058

## Technical information

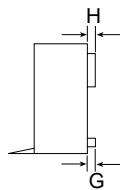
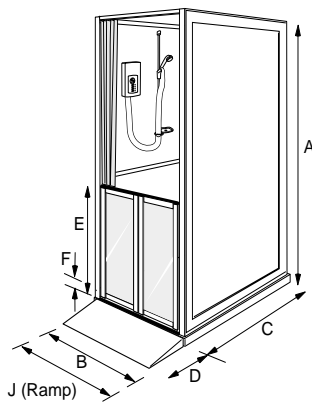

\*Add 100mm if side controls fitted.  
+Add 75mm if basin fitted.  
G=outlet pipe at rear of cubicle  
H=cistern  
Ramp size:  
890mm x 220mm

Ref	Dimensions
A	1900
B	895*+
C	1215
D	220
E	810
F	75
G	50
H	200
J	890

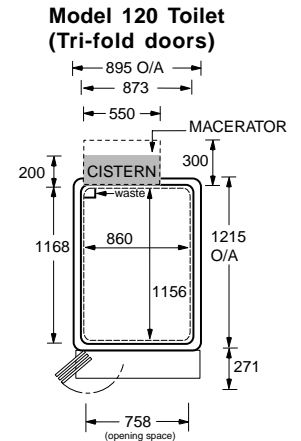
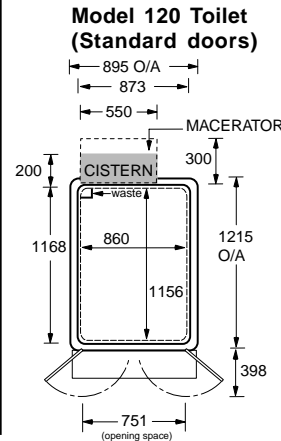

**Note:** Dimensions are for doors fully open.

**Internal dimensions:** The width is measured from acrylic panel to acrylic panel.

The depth is taken from the back acrylic panel to the inner face of the door.

\*Note: Macerators should be fitted by suitably qualified personnel

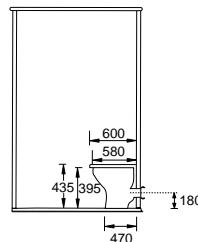

**Note:**  
centreline of waste (left) is taken from top of cubicle base

## Shower chair compatibility

See page 95 for shower chair compatibility options

Chiltern Invadex shower cubicles are available with a large range of options and accessories, allowing the cubicle to be configured to suit specific client requirements. A quick order form is available to help select the appropriate options. Please contact Customer Service for details or to arrange a visit by a Technical Sales Representative.

## SYMBOLS:

Bulk/oversized item



Made to order (see P192)



Tel: 0800 917 0399

www.chilterninvadex.co.uk

Fax: +44 (0) 1869 365588

sales@chilterninvadex.co.uk

# SIDE ENTRY MK2 SHOWER CUBICLE TOILET

## Cubicle kit contents:

- White Shower Tray
- Enclosure pack
- Door set - half height (not handed) or tri-fold (left or right hand) doors
- Curtain Track and Hooks (to suit door option)
- White Shower Curtain
- Detachable ramp
- Grab rails
- Shower unit options shown on p130 (not included in package price)
- Fitting instructions

## HOW TO ORDER



	Option 1	Option 2	Option 3
<b>Cubicle description</b>	<b>Half height door</b>	<b>Trifold (Left hand)</b>	<b>Trifold (Right hand)</b>
Side Entry MK2 Cubicle with pumped waste	Part no: SHTCUSE2PW Price: £1510	Part no: SHTCUSE2PW Price: £1510	Part no: SHTCUSE2PW Price: £1510
Side Entry MK2 Cubicle with gravity waste	Part no: SHTCUSE2G Price: £1275	Part no: SHTCUSE2G Price: £1275	Part no: SHTCUSE2G Price: £1275

## Technical information

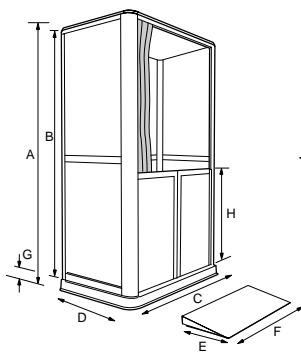

**Notes:**  
 \*Add 100mm if side controls fitted.  
 +Add 75mm if basin fitted.  
 The Side Entry MK2 is available with a removable ramp - standard 250mm or longer graduated 500mm version.  
 J=outlet pipe at rear of cubicle  
 K=cistern

Ref	Dimensions
A	2040
B	1950
C	1205 * +
D	760
E	250
F	1025
G	60
H	810
J	50
K	200

### SIDE ENTRY MK2 TOILET (Standard doors)

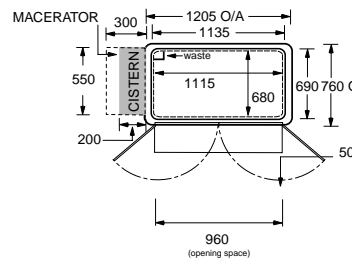

### SIDE ENTRY MK2 TOILET (Tri-fold doors)

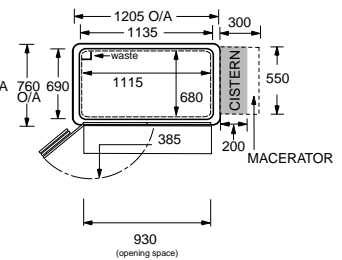

**Note:** Dimensions are for doors fully open.

**Internal dimensions:** The width is measured from acrylic panel to acrylic panel. The depth is taken from the back acrylic panel to the inner face of the door.

### Shower chair compatibility

See page 95 for shower chair compatibility options

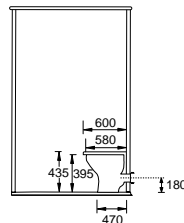

**Note:** centreline of waste (left) is taken from top of cubicle base

Chiltern Invadex shower cubicles are available with a large range of options and accessories, allowing the cubicle to be configured to suit specific client requirements. A quick order form is available to help select the appropriate options. Please contact Customer Service for details or to arrange a visit by a Technical Sales Representative.

### SYMBOLS:

Bulk/oversized item



Made to order (see P192)



Tel: 0800 917 0399

www.chilterninvadex.co.uk

Fax: +44 (0) 1869 365588

sales@chilterninvadex.co.uk

# CUBICLE SEATS

## SIDE ENTRY MK2

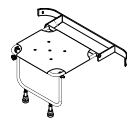
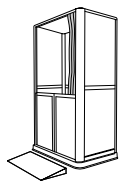

Tip-up PVC Shower Seat, with Adjustable Folding Support Legs  
code: SHSS4SEMK2  
£150.00

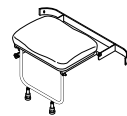

Tip-up Padded Seat, with adjustable folding support legs  
code: SHSS4PSEMK2  
£225.00

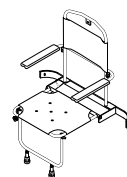

Tip-up PVC shower seat, with folding legs/ arms/ fixed backrest  
code: SHSS5SEMK2  
£220.00



Tip-up shower seat, with horseshoe/ aperture/ flat padded seat with folding legs/arms, fixed backrest  
code: SHSS5PSE2FP  
£316.00

## CORNER CUBICLE

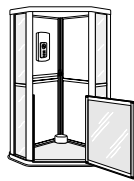

Shower stool  
code: IDPBS01  
£53.90

## FRONT ENTRY 100MK2

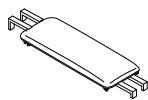

Padded bench seat, with or without aperture (does not fold away)  
code: SHSS3100  
£130.00

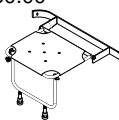

Tip-up PVC shower seat, with adjustable folding support legs  
code: SHSS4100  
£150.00



Tip-up Padded Seat, with adjustable folding support legs  
code: SHSS4P100  
£225.00

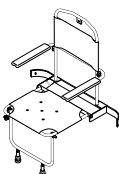

Tip-up PVC shower seat, with folding legs/arms/ fixed backrest  
code: SHSS5100  
£220.00

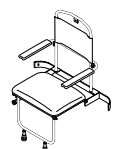

Tip-up shower seat, with horseshoe/ aperture/ flat padded seat with folding legs/arms, fixed backrest  
code: SHSS5P100  
£316.00

## FRONT ENTRY 75,101,120

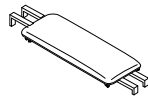
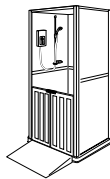

Padded bench seat, with or without aperture (does not fold away)  
code: SHSS375/ SHSS3101/SHSS3120  
£130.00

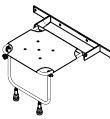

Tip-up PVC shower seat, with adjustable folding support legs  
code: SHSS475/ SHSS4101/SHSS4120  
£150.00



Tip-up Padded seat, with adjustable folding support legs  
code: SHSS4P75/ SHSS4P101/SHSS4P120  
£225.00

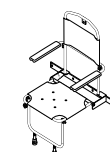

Tip-up PVC shower seat, with folding legs/arms, fixed backrest  
code: SHSS575/ SHSS5101/SHSS5120  
£220.00

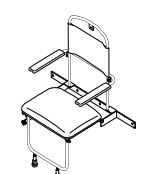

Tip-up shower seat, with horseshoe/ aperture/ flat padded seat with folding legs/arms/ fixed backrest  
code: SHSS5P75/ SHSS5P101/SHSS5P120  
£316.00

## SLIMLINE SIDE ENTRY

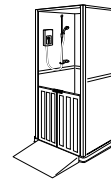

Padded bench seat, with or without aperture (does not fold away)  
code: SHSS2SL  
£130.00

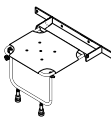

Tip-up PVC shower seat, with adjustable folding support legs  
code: SHSS4S/L  
£150.00



Tip-up Padded seat, with adjustable folding support legs  
code: SHSS4PS/L  
£225.00

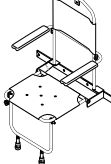

Tip-up PVC shower seat, with folding legs & arms, fixed backrest  
code: SHSS5S/L  
£220.00



Tip-up shower seat with horseshoe/ aperture/ flat padded seat with folding legs & arms, fixed backrest  
code: SHSS5PS/E  
£316.00

## SIDE ENTRY MK1

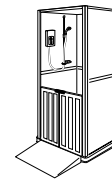

Padded bench seat, with or without aperture (does not fold away)  
Side Entry Mk1  
code: SHSS2SE  
£130.00

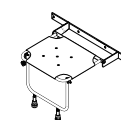

Tip-up PVC shower seat, with adjustable folding support legs  
code: SHSS4SE  
£150.00

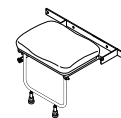

Tip-up Padded seat, with adjustable folding support legs  
code: SHSS4PSE  
£225.00

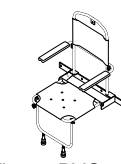

Tip-up PVC shower seat with folding legs/arms/ fixed backrest  
code: SHSS5SE  
£220.00

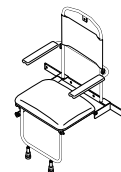

Tip-up shower seat, with horseshoe/ aperture/ flat padded seat with folding legs/arms/ fixed backrest  
code: SHSS5PS/E  
£316.00

Note: Cubicle model must be stated at point of order.  
Shower seats for cubicles have a maximum load 127kg (20 stones) (279lb)

### SYMBOLS:

Bulk/oversized item



Made to order (see P192)



Tel: 0800 917 0399

www.chilterninvadex.co.uk

Fax: +44 (0) 1869 365588

sales@chilterninvadex.co.uk

# CUBICLE SEATS - SEAT DETAIL

## Shower Cubicle Seats - Information for ordering

Chiltern Invadex produce a wide range of seats for use with the Shower Cubicle range. Basic size information is shown below. Seats can be made to order (extended delivery times apply).

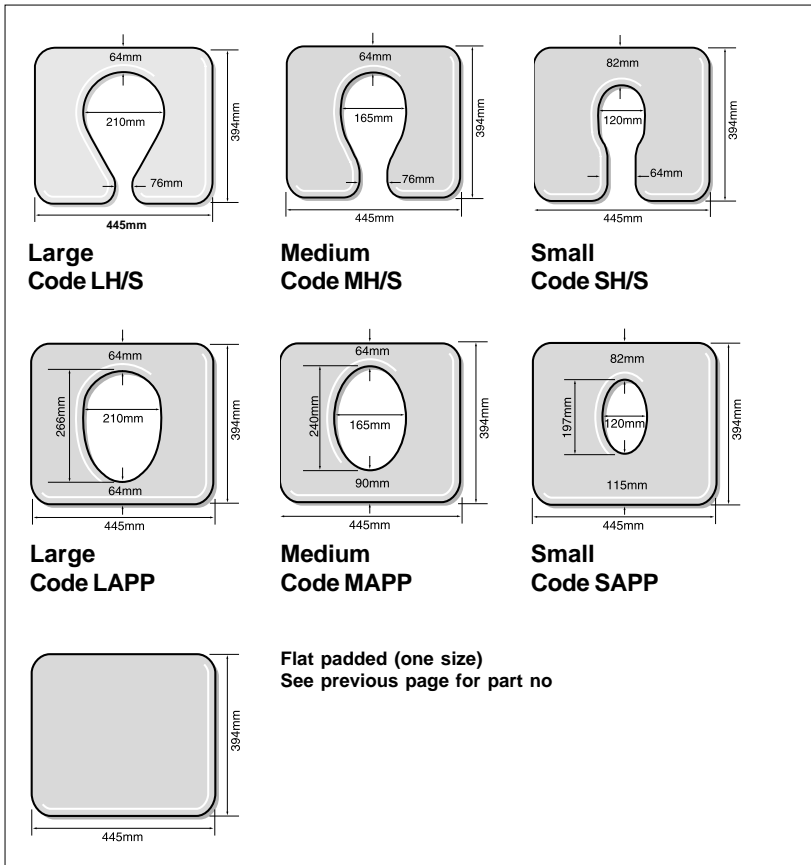

**SYMBOLS:**

Bulk/oversized item



Made to order (see P192)



Tel: 0800 917 0399

www.chilterninvadex.co.uk

Fax: +44 (0) 1869 365588

sales@chilterninvadex.co.uk

# SANITARY SYSTEMS



## Saniplus Small bore sanitary system

- Breaks down toilet waste from a shower, wash basin or W.C for pumping away through a small bore (22mm) pipe
- A powerful motor enables the unit to pump the waste and water up to 5m vertically, 100m horizontally or a lesser combination of both, where conventional large bore pipework is impractical
- Features a new case with sound reduction and integrated carbon filter
- Can be used with Whale pump option

code	product	Price
SH0411	Saniplus sanitary system	£585

## Technical information

- Motor induction motor (no carbon brushes or gears to wear out). Tested over 30,000 cycles.
- Watts (Consumption) 400w
- Electrical Supply 220-240V 50Hz
- Flow rate at max head l/min 40 Horizontal Discharge 100 metres
- Vertical Discharge 5 metres
- Gravity fall on horizontal installations 1:100
- Discharge Pipe Diameter 22mm
- Materials Polypropylene, C.R.P., stainless steel, Neoprene Type of WC Pan (not included)
- Short spigot 100mm HO outlet (BS EN 33/37) Motor RPM 2800 RPM
- Normal Running Time WC 10–20 secs approx or as required, to discharge bath, shower etc
- Dimensions (vertical height is measured from floor level) 512W x 305 O/H x 200D (requires 210mm behind spigot)

Technote Designed to fit BS EN 33/37 WC pans.

As close coupled cistern dimensions vary, it may be necessary, with certain designs, to utilise a spacer between cistern and wall

## Saniplus small bore sanitary system (shown with Whale pump option)

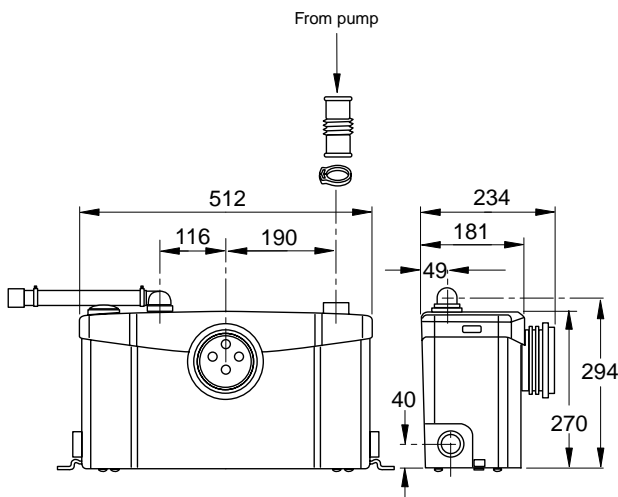

### Saniplus small bore sanitary system with Whale pump

**Please contact the Technical Helpdesk on 01869 365500 if this option is required.**

Where the situation demands, or if the pipe run is greater than that specified for the Whale pump a Saniplus small bore sanitary system may be used. The discharge from the Whale pump must go into the top of the Saniplus small bore sanitary system.

**Do not use the bottom entries.**

It is preferable to have two separate discharge lines to waste and drainage when used in the same room as a Saniplus small bore sanitary system. Any failure of the Saniplus small bore sanitary system will not be detected by the Whale pump.

## Pumping distance illustration

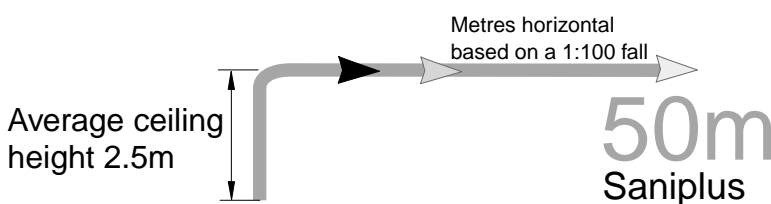

NB: Vertical lift must precede horizontal run

Note: If you increase 'horizontal' pipe fall to full 1:40 gravity fall, then the horizontal distance can be increased to virtually any distance required (also increase pipe size)

## Pump/macerator shown in relation to a Chiltern Invadex Shower Cubicle Toilet

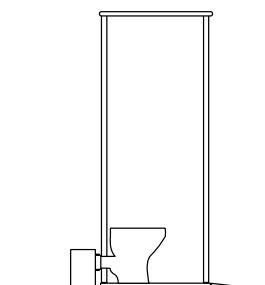

### SYMBOLS:

Bulk/oversized item



Made to order (see P192)



Tel: 0800 917 0399

www.chilterninvadex.co.uk

Fax: +44 (0) 1869 365588

sales@chilterninvadex.co.uk