

SHOWER CHAIRS



TransAqua Self Propelled Shower & Toileting Chair Maximum Load 200kg (31 stones) (440lb)

- Corrosion resistant modular stainless steel frame
- HF welded seat
- Swingaway removable fixed height locking armrests
- Swingaway removable height adjustable legrests with composite footplates
- Choice of removable seat styles and sizes
- Fixed height backrest with pushbar
- Braked Castors (for added safety during transfer)

code	product	seat options	Price
TA18SP	TransAqua Self Propelled	Horseshoe, Aperture, Flat Padded Seat 18" (450mm)	from £480
TA21SP	TransAqua Self Propelled	Horseshoe, Aperture, Flat Padded Seat 21" (525mm)	from £649

Chiltern Invadex shower chairs are available with a large range of options and accessories (including Clos-o-Mat compatible models - see page 184), allowing the chair to be configured to suit specific client requirements. An electronic codebreaker and quick order form are available to help select the appropriate standard options. Please contact Customer Service for details or to arrange a visit by a Technical Sales Representative. Available with extended seat option and with or without footplates. Self propelling models are available with a choice of wheel size options - 20", 22", 24". Prices shown are for standard chair (22" wheel). Additional charge applies for optional extras.



TransAqua Attendant Propelled Shower & Toileting Chair Maximum Load 200kg (31 stones) (440lb)

- Corrosion resistant modular stainless steel frame
- HF welded seat
- Swingaway removable fixed height locking armrests
- Swingaway removable height adjustable legrests with composite footplates
- Choice of removable seat styles and sizes
- Fixed height backrest with pushbar
- Braked Castors (for added safety during transfer)

code	product	seat options	Price
TA18AP	TransAqua Attendant Propelled	Horseshoe, Aperture, Flat Padded Seat 18" (450mm)	from £353
TA21AP	TransAqua Attendant Propelled	Horseshoe, Aperture, Flat Padded Seat 21" (525mm)	from £579

Chiltern Invadex shower chairs are available with a large range of options and accessories (including Clos-o-Mat compatible models - see page 184), allowing the chair to be configured to suit specific client requirements. An electronic codebreaker and quick order form are available to help select the appropriate standard options. Please contact Customer Service for details or to arrange a visit by a Technical Sales Representative. Available with extended seat option and with or without footplates. Additional charge applies for optional extras.

TransAqua Shower chair custom made features

code	selection	Price
	Without seat	-£45
	Commode Pan Cradle & Fittings (Not suitable for use with Padded Flat Seat)	£15
	Seat extended by 50mm	£31
	Increase seat height by 25mm	£26
	Height adjustable armrest	£62
	Footrests with toe straps	£49
	Commode pan cradle	£15
	Chair supplied assembled	£26

Prices quoted above apply when ordered with a chair. The complete range of accessories is shown overleaf. Prices quoted for custom made features are nett prices

Technical information

Note: Dimensions are for guidance only. For comprehensive dimensional information see the Chiltern Invadex AquaMaster brochure. Dimensions are based on 22" diameter wheel.

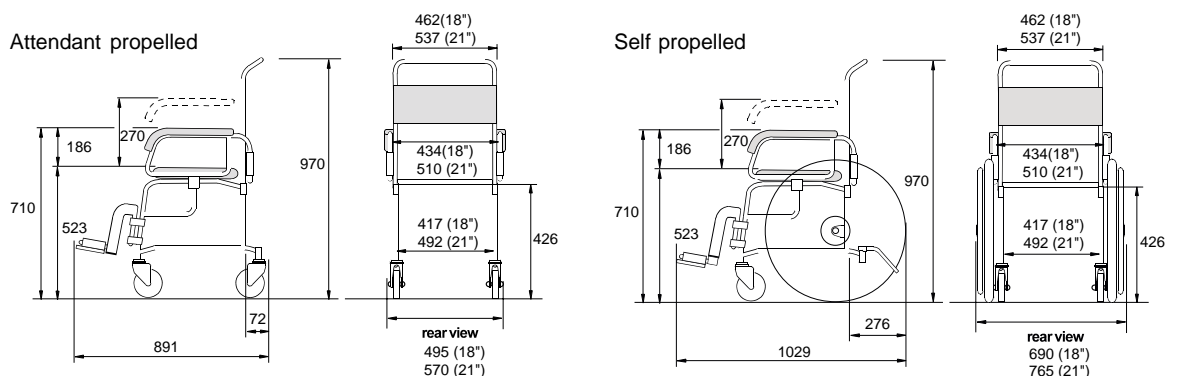

SYMBOLS:

Bulk/oversized item



Made to order (see P200)



Tel: 0800 917 0399

www.chilterninvadex.co.uk

Fax: +44 (0) 1869 365588

sales@chilterninvadex.co.uk

SHOWER CHAIRS

TransAqua shower chair accessories

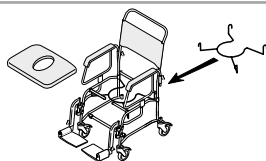

Commode pan cradle

211-00513 Commode cradle £15

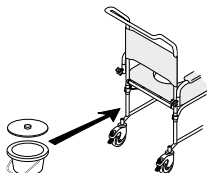

Commode pan

201-00147 Commode pan (ROUND) £27

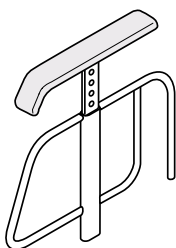

Stainless steel adjustable armrest

Adjustable from 160-275mm (from the seat) for increased comfort and to suit a range of disabilities.

211-00512 Stainless steel armrest £82

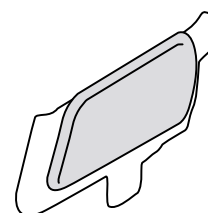

Side pads

1", 2", 3" options. Reduces internal width from 18" down to 12" (using a 3" side pad on each side) offering additional support and flexibility to suit user's down to paediatric requirements (Note: only compatible with fixed armrests, not height adjustable option)

201-00539 Side pads (1") padding £66
201-00540 Side pads (2") padding £66
201-00541 Side pads (3") padding £66

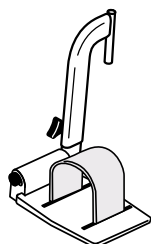

Footrests with toe straps

Used instead of standard footplates. Prevents involuntary movements and protects the user/carer against injury.

211-00522 Right hand (as sat in chair) £49
211-00523 Left hand (as sat in chair) £49

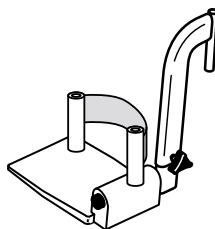

Footrests with heel straps

Provides additional support for feet. Prevents the user from slipping off the back and falling forwards.

211-00520 Right hand (as sat in chair) £49
211-00521 Left hand (as sat in chair) £49

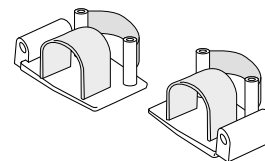

Footrests with heel straps/toe straps

Provides total support of feet against involuntary movement

211-00525 Footrests c/w heel & toe(LH) £76
211-00524 Footrests c/w heel & toe (RH) £76

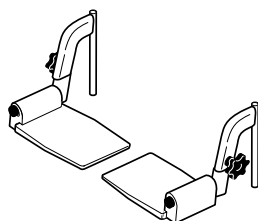

Short Footrests

Used instead of standard footrests where feet require support at a higher level (18 and 90 degree options).

18 Degree
211-00528 Left hand (as sat in chair) £28
211-00529 Right hand (as sat in chair) £28
90 Degree
211-00530 Left hand (as sat in chair) £28
211-00531 Right hand (as sat in chair) £28

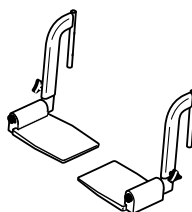

90 degree footrests

Use instead of standard footrests, where space is limited, or if the users posture requires feet to be positioned closer to the chair frame

211-00526 90 degree footrests (LH) £28
211-00527 90 degree footrests (RH) £28

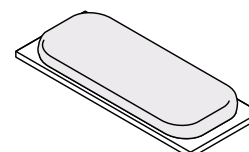

Padded foot tray

Soft padded support to suit sensitive feet. Clips over standard footplates.

201-00136 Foot tray 450mm (18") £60
203-00049 Foot tray 525mm (21") £94

SYMBOLS:

Bulk/oversized item



Made to order (see P200)



Tel: 0800 917 0399

www.chilterninvadex.co.uk

Fax: +44 (0) 1869 365588

sales@chilterninvadex.co.uk

SHOWER CHAIRS

TransAqua shower chair accessories



Waist strap

Buckle or Velcro type options. Supports the waist and prevents involuntary movement of upper body/ accidentally slipping out of chair.

201-00113 Velcro type (to suit 18") £17
 203-00046 Velcro type (to suit 21") £17
 201-00085 Buckle strap (to suit 18") £17*
 203-00014 Buckle strap (to suit 21") £17*

* CHCS027 x2 required £5.50 ea



Full support harness

Prevents involuntary movement of upper body/ accidentally slipping out of chair.

201-00143 To suit 18" shower chair £57

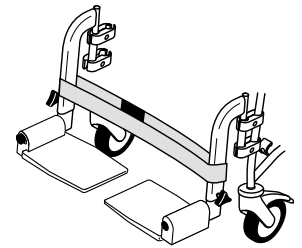

Calf strap

Attaches around both footrest holders. Provides support to the lower leg.

201-00146 Calf strap (to suit 18") £10
 203-00050 Waist strap (to suit 21") £10

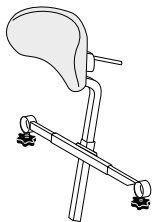

Head support

Provides padded support for the users head (fully adjustable to suit)

CHCS3051 Head support (straight handle) £248

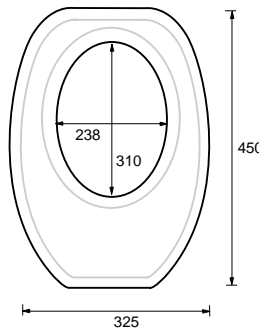

Toilet splash guard

CHSPLASH Toilet splash guard £29

SYMBOLS:

Bulk/oversized item



Made to order (see P200)



Tel: 0800 917 0399

www.chilterninvadex.co.uk

Fax: +44 (0) 1869 365588

sales@chilterninvadex.co.uk

SHOWER CHAIRS (CLOS-O-MAT PALMA VITA COMPATIBLE)



TransAqua (Clos-o-Mat) Self Propelled Shower Chair Maximum Load 200kg (31 stones) (440lb)

- Corrosion resistant modular stainless steel frame (19" wide)
- HF welded seat with fitted skirt to suit Clos-o-Mat Palma Vita automatic toilet
- Swingaway removable fixed height locking armrests
- Swingaway removable height adjustable legrests with composite footplates
- Choice of removable seat styles and sizes
- Fixed height backrest with pushbar
- Braked Castors (for added safety during transfer)



code	product	seat options	Price
TA19SP	TransAqua Self Propelled 19" wide (475mm)	Horseshoe or Aperture Seat	from £480
TA21SP	TransAqua Self Propelled 21" wide (525mm)	Horseshoe or Aperture Seat	from £649

Chiltern Invadex Clos-o-Mat compatible shower chairs are available with a large range of options and accessories, allowing the chair to be configured to suit specific client requirements. An electronic codebreaker and quick order form are available to help select the appropriate standard options. Please contact Customer Service for details or to arrange a visit by a Technical Sales Representative. Available with extended seat option and with or without footplates. Self propelling models are available with a choice of wheel size options - 20", 22", 24". Prices shown are for standard chair (22" wheel). Additional charge applies for optional extras.



TransAqua (Clos-o-Mat) Attendant Propelled Shower Chair Maximum Load 200kg (31 stones) (440lb)

- Corrosion resistant modular stainless steel frame (19" wide)
- HF welded seat with fitted skirt to suit Clos-o-Mat Palma Vita automatic toilet
- Swingaway removable fixed height locking armrests
- Swingaway removable height adjustable legrests with composite footplates
- Choice of removable seat styles and sizes
- Fixed height backrest with pushbar
- Braked Castors (for added safety during transfer)

code	product	seat options	Price
TA19AP	TransAqua Attendant Propelled 19" wide (475mm)	Horseshoe or Aperture Seat	from £353
TA21AP	TransAqua Attendant Propelled 21" wide (525mm)	Horseshoe or Aperture Seat	from £579

Chiltern Invadex Clos-o-Mat compatible shower chairs are available with a large range of options and accessories, allowing the chair to be configured to suit specific client requirements. An electronic codebreaker and quick order form are available to help select the appropriate standard options. Please contact Customer Service for details or to arrange a visit by a Technical Sales Representative. Available with extended seat option and with or without footplates. Additional charge applies for optional extras.

TransAqua (Clos-o-mat compatible) Shower chair custom made features

code	selection	Price
	1" (25mm) spacer to suit Clos-o-Mat Palma Vita with 1" (25mm) plinth	£26
	2" (50mm) spacer to suit Clos-o-Mat Palma Vita with 2" (50mm) plinth	£26
	Horseshoe seat with skirt (medium) to suit 19" chairs	£11
	Horseshoe seat with skirt (Large) to suit 19" chairs	£11
	Aperture seat with skirt (medium) to suit 19" chairs	£11
	Aperture seat with skirt (Large) to suit 19" chairs	£11
	Horseshoe seat with skirt (Large) to suit 21" chairs	£11
	Aperture seat with skirt (Large) to suit 21" chairs	£11

The complete range of accessories is shown on previous pages. Prices quoted above apply when ordered with a chair. Prices quoted for custom made features are nett prices. Other custom made features are available - see standard TransAqua shower chair page. A Palma Vita with a plinth above 2" will require a special shower chair from the Chiltern Invadex AquaMaster range.

Technical information

Note: Dimensions are based on 22" diameter wheel.

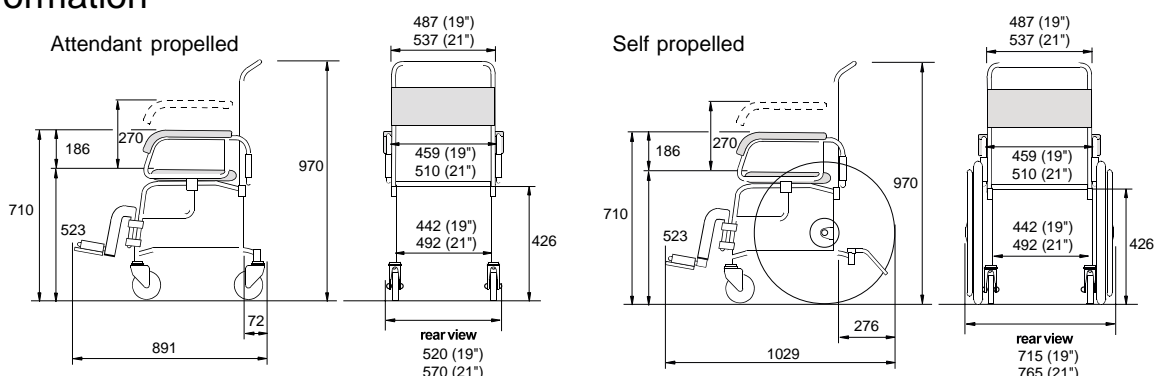

SYMBOLS:

Bulk/oversized item



Made to order (see P200)



Tel: 0800 917 0399

www.chilterninvadex.co.uk

Fax: +44 (0) 1869 365588

sales@chilterninvadex.co.uk