

SLINGS



Wispa Universal Slings

Maximum Load SLUQ (quilted) maximum load 200kg
 SLGU (not quilted) maximum load rated at 190kg

- Good support for legs, shoulders and back
- Easy to fit and remove
- Quilted/non quilted versions
- Positioning handles on reverse
- Commode aperture for toileting
- Free Sling Selection Guide available

code	product	size	Price
SLGU4	Universal Non Quilted	Small	£79
SLGU4RN	Universal Non Quilted Royal net	Small	£79
SLGU5	Universal Non Quilted	Medium	£89
SLGU5RN	Universal Non Quilted Royal net	Medium	£89
SLGU6	Universal Non Quilted	Large	£99
SLGU6RN	Universal Non Quilted Royal net	Large	£99
SLUQ7	Universal Quilted	Small	£116
SLUQ7RN	Universal Quilted Royal net	Small	£116
SLUQ8	Universal Quilted	Medium	£126
SLUQ8RN	Universal Quilted Royal net	Medium	£126
SLUQ9	Universal Quilted	Large	£136
SLUQ9RN	Universal Quilted Royal net	Large	£136
SLGU1S	Universal Sheepskin	Small	£147
SLGU2S	Universal Sheepskin	Medium	£158.20
SLGU3S	Universal Sheepskin	Large	£169.60

Note: If head and neck support are required, the Full Support Universal Sling may be preferable.

Technical Information

Universal Slings SLUQ7,8,9			
Ref	SLUQ7/SLGU4	SLUQ8/SLGU5	SLUQ9/SLGU6
A	875mm	1050mm	1200mm
B	1100mm	1245mm	1320mm
C	560mm	655mm	770mm
Size	Small	Medium	Large

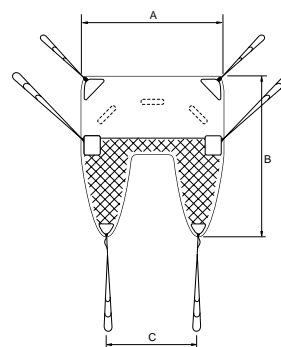

SYMBOLS:

Bulk/oversized item



Made to order (see P200)



Tel: 0800 917 0399

www.chilterninvadex.co.uk

Fax: +44 (0) 1869 365588

sales@chilterninvadex.co.uk

SLINGS



Wispa Full Support Universal Quilted Slings

Maximum Load SLUFQ XL 445kg

SLUFQ P2, P1, XS, S, M, L 200kg

- Good support for legs, shoulders and back
- Easy to fit and remove
- Quilted/non quilted versions
- Positioning handles on reverse
- Commode aperture for toileting
- Free Sling Selection Guide available

Note: If head and neck support are required, the Full Support Universal Sling may be preferable.

code	product	size	Price
SLUFQ-P2	Full Support Universal Quilted	Paediatric size 2	£121
SLUFQ-P1	Full Support Universal Quilted	Paediatric size 1	£121
SLUFQ-P1RN	Universal Quilted Full Support Royal net	Paediatric size 1	£118
SLUFQ-P2RN	Universal Quilted Full Support Royal net	Paediatric size 2	£118
SLUFQ-SRN	Universal Quilted Full Support Royal net	Small	£128
SLUFQ-XS	Full Support Universal Quilted	Extra Small	£126
SLUFQ-S	Full Support Universal Quilted	Small	£131
SLUFQ-M	Full Support Universal Quilted	Medium	£141
SLUFQ-L	Full Support Universal Quilted	Large	£153
SLUFQ-XL	Full Support Universal Quilted	Extra Large	£263
SLUFQ-XSRN	Universal Quilted FS Royal net	X-Small	£123
SLUFQ-MRN	Universal Quilted FS Royal net	Medium	£138
SLUFQ-LRN	Universal Quilted FS Royal net	Large	£149
SLUFQ-XLRN	Universal Quilted FS Royal net	X-Large	£256

Paediatric slings

Note: See page 167 for the complete range of paediatric slings.

Technical Information

Full Support Universal Sling SLUFQ S, M, L, XL				
Ref	SLUFQ S	SLUFQ M	SLUFQ L	SLUFQ XL
A	880mm	1015mm	1125mm	1275mm
B	1310mm	1395mm	1560mm	1680mm
C	560mm	640mm	755mm	850mm
Size	Small	Medium	Large	XLarge

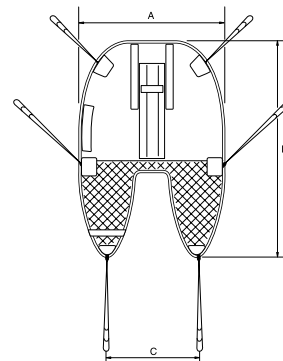

Technical Information

Full Support Universal Sling SLUFQ P2, P1, XS			
Ref	SLUFQ P2	SLUFQ P1	SLUFQ XS
A	590mm	670mm	780mm
B	960mm	1070mm	1140mm
C	430mm	450mm	500mm
Size	M child	L Child	X Small

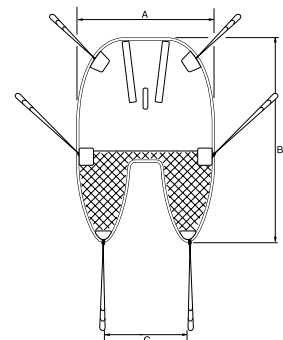

SYMBOLS:

Bulk/oversized item



Made to order (see P200)



Tel: 0800 917 0399

www.chilterninvadex.co.uk

Fax: +44 (0) 1869 365588

sales@chilterninvadex.co.uk

SLINGS



Wispa Hammock Slings













Maximum Load 200kg (31 stones) (440lb)

Hammock SLHQ 1, 2, 3

- Excellent support for head/neck, shoulders, back, hips, buttocks and thighs
- Support for upper thigh and hip means that the sling is suitable for hoisting clients with above knee amputations

Double Amputee Sling SLHQ 8 (one size only)

- Similar to the medium Hammock sling, but without head support
- Free Sling Selection Guide available

code	product	size		Price
SLHQ1	Hammock Quilted	Small		£116
SLHQ1RN	Hammock Quilted Royal net	Small		£116
SLHQ2	Hammock Quilted	Medium		£126
SLHQ2RN	Hammock Quilted Royal net	Medium		£126
SLHQ3	Hammock Quilted	Large		£136
SLHQ3RN	Hammock Quilted Royal net	Large		£136
SLHQ8	Amputee Sling Quilted	Medium		£126
SLHQ8RN	Amputee Quilted D/A Royal net	Medium		£123
SLGH1	Hammock Non Quilted	Small		£96.10
SLGH1RN	Hammock Non Quilted Royal net	Small		£96.10
SLGH1S	Hammock Sheepskin	Small		£141.20
SLGH2	Hammock Non Quilted	Medium		£107.40
SLGH2RN	Hammock Non Quilted Royal net	Medium		£107.40
SLGH2S	Hammock Sheepskin	Medium		£152.60
SLGH3	Hammock Non Quilted	Large		£118.70
SLGH3S	Hammock Sheepskin	Large		£163.80

Technical Information

Hammock Sling SLHQ 1, 2, 3 Amputee Sling SLHQ8				
Ref	SLHQ1	SLHQ2	SLHQ3	SLHQ 8
A	515mm	510mm	650mm	925mm
B	1020mm	1290mm	1330mm	1175mm
C	740mm	880mm	1045mm	925mm
Size	Small	Medium	Large	Double amputee

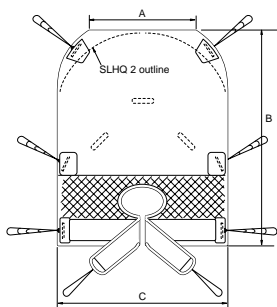

SLHQ1/2/3

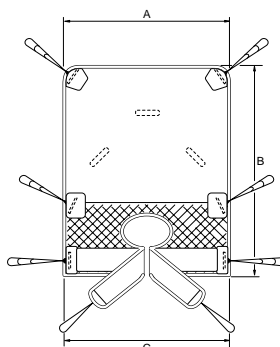

SLHQ8

SYMBOLS:

Bulk/oversized item



Made to order (see P200)



Tel: 0800 917 0399

www.chilterninvadex.co.uk

Fax: +44 (0) 1869 365588

sales@chilterninvadex.co.uk

SLINGS



Wispa Standing Jackets

Maximum Load 200kg (31 stones) (440lb)

- Useful for therapy and may assist with transfers into standing frames
- Graduated loops on shoulder straps allow for variations in posture to be accommodated
- Padded for extra comfort
- Leg support straps are easy to apply while in the seated position
- Leg support straps have removable padded covers and are easy to apply
- Metal slide lock adjusters combine rapid adjustment with load bearing security
- Free Sling Selection Guide available

code	product	size	Price
SLST-XS	Wispa Standing Jacket	Chest size 59cm-82cm (23"-32")	£240
SLST-S	Wispa Standing Jacket	Small - chest size 76cm-98cm (30"-38")	£240
SLST-M	Wispa Standing Jacket	Medium - chest size 89cm-112cm (35"-44")	£250
SLST-L	Wispa Standing Jacket	Large - chest size 104cm-126cm (41"-50")	£260

Paediatric slings

Note: See page 178 for the complete range of paediatric slings.

Technical Information

Standing Jacket SLST XS, S, M, L			
Ref	SLST S	SLST M	SLST L
A	970mm	1120mm	1270mm
B	215mm	215mm	215mm
Size	Small	Medium	Large

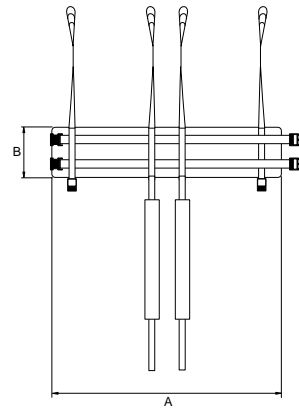

Technical Information

Standing Jacket SLST XS	
Ref	SLST XS
A	820mm
B	215mm
Size	XSmall

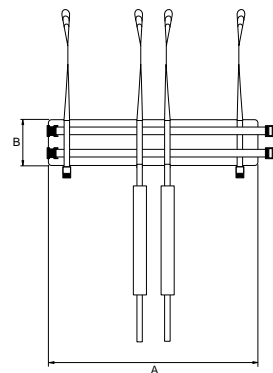

SYMBOLS:

Bulk/oversized item



Made to order (see P200)



Tel: 0800 917 0399

www.chilterninvadex.co.uk

Fax: +44 (0) 1869 365588

sales@chilterninvadex.co.uk

SLINGS



Wispa Slinci Sling

Maximum Load excluding extra large 200kg (31 stones) (440lb)
 Extra large Maximum Load 272kg (42 stones) (440lb)

- Low friction outer fabric and absence of positioning handles decreases resistance for ease of application
- Ease of access to posture control seating
- Specially designed for ease of application and removal in both moulded and special seating, or where space is limited
- Good support for head, legs, shoulders and back
- Commode aperture for toileting
- Sizes range from P2/1 to suit children to XL (XL maximum load 272kg) to compliment the Wispa 300 series overhead hoist

code	product	size	Price
SLINCI-P2	Slinci sling	Paediatric size 2	£121
SLINCI-P1	Slinci sling	Paediatric size 1	£121
SLINCI-XS	Slinci sling	Extra small	£126
SLINCI-S	Slinci sling	Small	£132
SLINCI-M	Slinci sling	Medium	£143
SLINCI-L	Slinci sling	Large	£153
SLINCI-XL	Slinci sling	Extra large	£263

Paediatric slings

Note: See page 167 for the complete range of paediatric slings.

Technical Information

Slinci Sling S, M, L, XL				
Ref	SLINCI S	SLINCI M	SLINCI L	SLINCI XL
A	880mm	1015mm	1125mm	1275mm
B	1310mm	1395mm	1560mm	1680mm
C	560mm	640mm	755mm	850mm
Size	Small	Medium	Large	Extra large

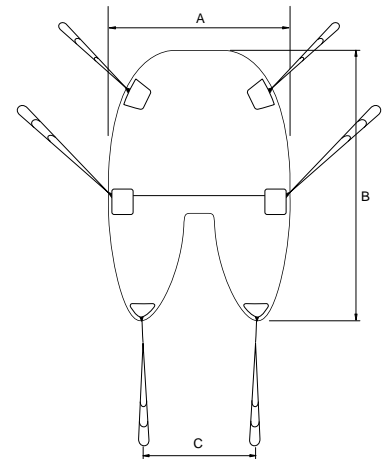

Technical Information

Slinci Sling P2, P1, XS			
Ref	SLINCI P2	SLINCI P1	SLINCI XS
A	590mm	670mm	780mm
B	960mm	1070mm	1140mm
C	430mm	450mm	500mm
Size	M Child	L Child	X Small

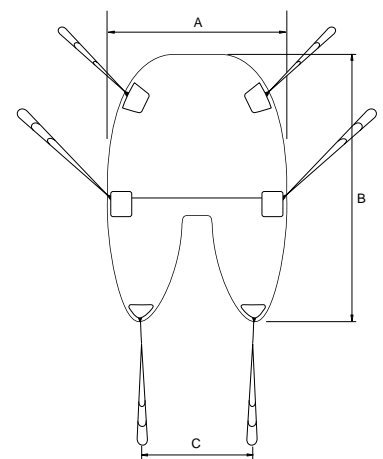

SYMBOLS:

Bulk/oversized item



Made to order (see P200)



Tel: 0800 917 0399

www.chilterninvadex.co.uk

Fax: +44 (0) 1869 365588

sales@chilterninvadex.co.uk

SLINGS



Wispa Recumbent Sling

Maximum Load 200kg (31 stones) (440lb)

- Facilitates hoisting in the recumbent position
- Fits under head, shoulders, buttocks and thighs
- Safe, comfortable transfer
- Centre leg straps for added safety during transfer
- Graduated loops on all straps for precise adjustment
- Free Sling Selection Guide available

code	product	size		Price
SLREC	Recumbent Sling	Medium		£153
SLRECRN	Recumbent Sling Royal net			£149

Technical Information

Recumbent Sling	
Ref	Medium
A	880mm
B	1390mm
C	880mm
Size	(one size only)

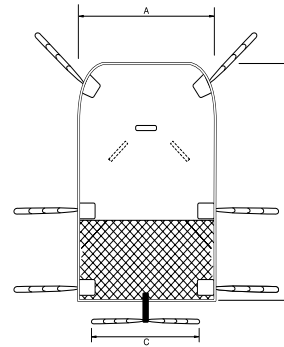

Toileting Fully Quilted Slings

Maximum Load 200kg (31 stones) (440lb)

- Quick and easy to fit and remove
- Good access for clothing removal/toileting
- Fully quilted
- Supports client under thighs and across mid-back area

Safety Note: This Sling is not considered suitable for clients with involuntary movement or limited postural control. This sling requires the clients arms to be positioned outside of the sling prior to hoisting.

code	product	size		Price
SLGTQ-P	Toileting/Access	paediatric one size		£163
SLGTQ4	Toileting Sling Fully Quilted	Small		£143
SLGTQ4RN	Toileting Quilted Royal net	Small		£139
SLGTQ5	Toileting Sling Fully Quilted	Medium		£153
SLGTQ5RN	Toileting Quilted Royal net	Medium		£148.60
SLGTQ6	Toileting Sling Fully Quilted	Large		£163

Technical Information

Toileting/Access Sling SLGTQ 4, 5, 6, P				
Ref	SLGTQ4	SLGTQ5	SLGTQ6	SLGTQ-P
A	1220mm	1300mm	1600mm	970mm
B	730mm	930mm	1110mm	730mm
C	370mm	480mm	600mm	340mm
Size	Small	Medium	Large	Paediatric

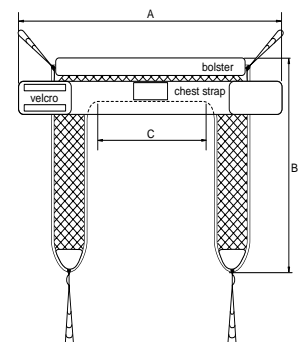

SYMBOLS:

Bulk/oversized item

Made to order (see P200)

Tel: 0800 917 0399

www.chilterninvadex.co.uk

Fax: +44 (0) 1869 365588

sales@chilterninvadex.co.uk

SLINGS



Wispa Paediatric Slings

Maximum Load 200kg (31 stones) (440lb)

- Positioning handles on reverse
- Good support for legs and shoulders
- Removable head support stiffeners
- Soft quilting on leg sections
- Free Sling Selection Guide available

code	product	size	Price
SLGTQ-P	Toileting/Access* (shown above)	One size	£163
SLUFQ-P2	Full Support Universal Quilted	Paediatric size 2	£121
SLUFQ-P1	Full Support Universal Quilted	Paediatric size 1	£121
SLUFQ-P1RN	Universal Quilted Full Support Royal net	Large	£118
SLUFQ-P2RN	Universal Quilted Full Support Royal net	Medium	£118
SLUFQ-XSRN	Universal Quilted FS Royal net	X-Small	£123
SLUFQ-XS	Full Support Universal Quilted	Extra Small	£126
SLINCI-P2	Slinco sling	Paediatric size 2	£121
SLINCI-P1	Slinco sling	Paediatric size 1	£121
SLINCI-XS	Slinco sling	Extra small	£126
SLST-XS	Wispa Standing Jacket	Chest size 59cm-82cm (23"-32")	£240

Technical Information

Full Support Universal Sling SLUFQ P2, P1, XS			
Ref	SLUFQ P2	SLUFQ P1	SLUFQ XS
A	590mm	670mm	780mm
B	960mm	1070mm	1140mm
C	430mm	450mm	500mm
Size	M child	L Child	X Small

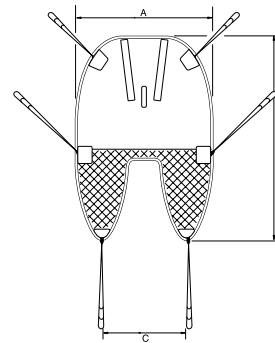

Technical Information

Slinco Sling P2, P1, XS			
Ref	SLINCI P2	SLINCI P1	SLINCI XS
A	590mm	670mm	780mm
B	960mm	1070mm	1140mm
C	430mm	450mm	500mm
Size	M Child	L Child	X Small

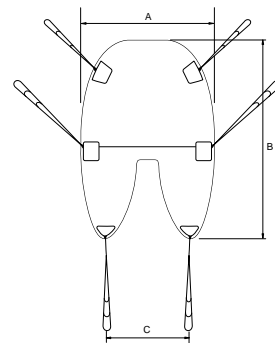

Technical Information

Standing Jacket SLST XS	
Ref	SLST XS
A	820mm
B	215mm
Size	XSmall

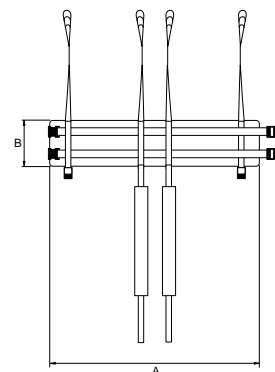

SYMBOLS:

Bulk/oversized item



Made to order (see P200)



Tel: 0800 917 0399

www.chilterninvadex.co.uk

Fax: +44 (0) 1869 365588

sales@chilterninvadex.co.uk

SLINGS



Wispa Patient Specific Disposable Sling

Maximum Load 200kg (31 stones) (440lb)

- Designed to stay with the client
- Reduced cross infection risk
- A cost effective solution
- Readily available
- Good support for legs, shoulders, back and head for a safe and comfortable lift
- Strong, lightweight and durable
- Removable head support stiffeners option
- Free Sling Selection Guide available

code	product	size	Price
SLD001	Wispa Patient Specific Sling	Medium (box of 10)	£120
SLD001-1	Wispa Patient Specific Sling	Medium (Each)	£12.99
SLD010	Head support stiffeners	(pair, removable)	£3.50

Technical Information

Disposable Sling	
Ref	SLD001
A	1000mm
B	1295mm
C	780mm
Size	(one size only)

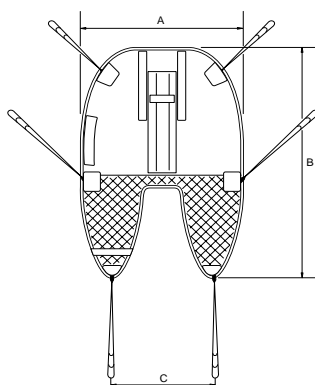

Wispa Bariatric blanket Sling

Maximum Load 445kg (70 stones) (980lbs)

- Suitable for use with the heavy duty gantry for extremely heavy clients (shown on page 163)
- The Bariatric Blanket Sling is manufactured from polyester toweling (top layer), fire retardant polyester fibre (middle layer), fire retardant polyester (middle layer), 4oz nylon (bottom layer)

code	product	size	Price
SLBB	Wispa Bariatric blanket sling	One size	£310

Safety note: Always ensure that the maximum load of the hoist and bariatric carry bar are not exceeded prior to any transfer.

SYMBOLS:

Bulk/oversized item



Made to order (see P200)



Tel: 0800 917 0399

www.chilterninvadex.co.uk

Fax: +44 (0) 1869 365588

sales@chilterninvadex.co.uk

SLINGS

Wispa Sling Accessories

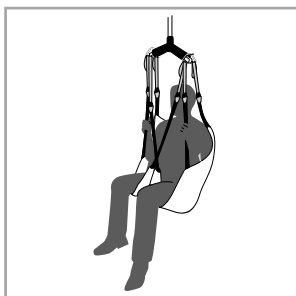

Wispa extension straps

Maximum Load 200kg (31 stones) (440lb)

- Creates greater distance between the client and carry bar
- Makes lifting from the floor easier when using a mobile hoist
- Greater head clearance for ceiling track hoist users
- Two separate loops to allow the position of the client to be adjusted to suit individual requirements
- Easy to fit and remove
- Free Sling Selection Guide available

code	product	size	Price
SLEXT	Extension Straps (pair)	One size - total length of strap 30cm	£37

Technical Information

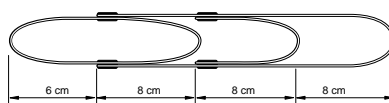

Custom made sling features

Special feature	Price
Wider sling	£24
Longer sling	£27
Strap alteration (longer, shorter, additional or fewer loops) per pair	£24
Additional straps per pair	£24
Add or remove handles	£24
Change of leg length (up to 100mm longer or shorter)	£27
Change of leg length (up to 200mm longer or shorter)	£40
Add or remove head support to any sling (boned or unboned)	£32
Change of length of existing head support	£24
Add or remove back support (plastozote padding)	£33
Add chest strap	£36
Change length of chest strap	£21
Add Terry toweling	£56
Add simulated sheepskin lining	£56
Add polyester lining	£33
Change aperture size	£36
Remove quilting	£33

Please note: A specification sheet is available for detailing special sling requirements. Please contact Customer Service to request a copy. Prices quoted for custom made features are nett prices.

Safety standards and tests

Sample slings have been load tested in accordance with ISO 10535 (2006) Hoists for the transfer of disabled persons - Requirements and test methods and conform to the requirements of the standard. The composite sample of the material used in Wispa slings meets the flammability performance requirements of BS EN 1021-1:1994 for upholstered furniture.

Hoist and sling compatibility

Chiltern Invadex can supply a detailed statement on hoist and sling compatibility produced by the British Healthcare Trades Association (BHTA). A copy of the statement can be viewed at www.chilterninvadex.co.uk/useful_info.htm or by contacting the Chiltern Invadex Customer Service Office at sales@chilterninvadex.co.uk.

SYMBOLS:

Bulk/oversized item



Made to order (see P200)



Tel: 0800 917 0399

www.chilterninvadex.co.uk

Fax: +44 (0) 1869 365588

sales@chilterninvadex.co.uk