

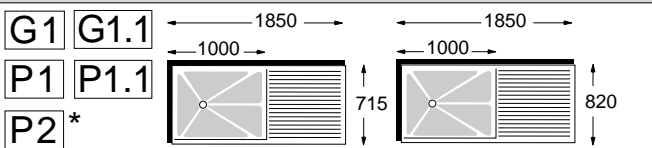

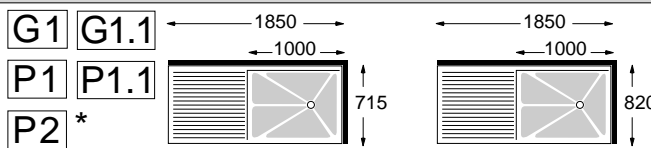

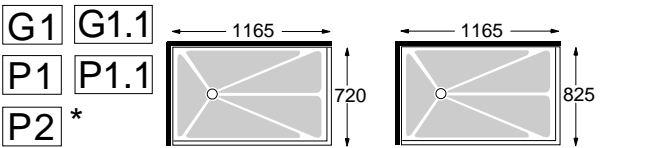

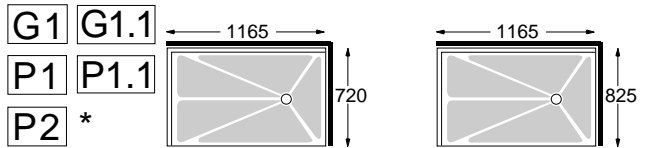
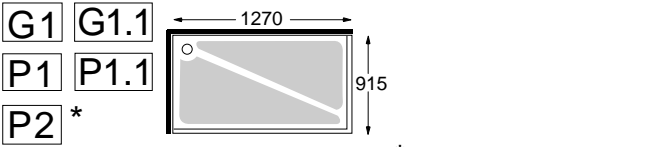
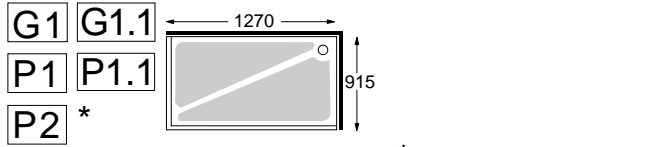
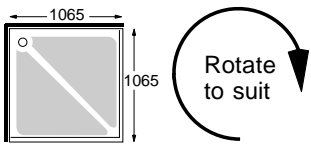

SHOWER TRAY SELECTOR - LEVEL ACCESS SHOWER TRAYS

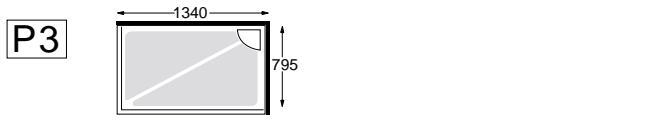
Use this shower tray selector to choose the handing and tray size required. The key at the foot of the page explains the symbols used throughout this section.

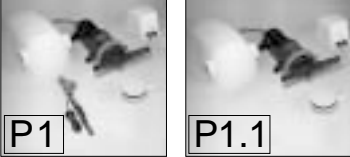
SANDWELL MK3 655 SANDWELL MK3 760  LEFT HAND <i>*Shower Waste Pump option suitable for timber joist situation with typical void - see p48-49.</i>		SANDWELL MK3 655 SANDWELL MK3 760  RIGHT HAND <i>*Shower Waste Pump option suitable for timber joist situation with void - see p48-49.</i>	
WESTDALE 655 WESTDALE 760  LEFT HAND <i>*Shower Waste Pump option suitable for timber joist situation with void - see p48-49.</i>		WESTDALE 655 WESTDALE 760  RIGHT HAND <i>*Shower Waste Pump option suitable for timber joist situation with void - see p48-49.</i>	
WESTDALE 850  LEFT HAND <i>*Shower Waste Pump option suitable for timber joist situation with void - see p48-49.</i>		WESTDALE 850  RIGHT HAND <i>*Shower Waste Pump option suitable for timber joist situation with void - see p48-49.</i>	
WESTDALE 1000  NOT HANDED <i>*Shower Waste Pump option suitable for timber joist situation with void - see p48-49.</i>			
CARDALE MK2  LEFT HAND		CARDALE MK2  RIGHT HAND	
GRAVITY WASTE OPTIONS Gravity waste (Invawaste) See pages 39-41 for comprehensive details 		PUMPED WASTE OPTIONS Whale Shower Drain Pump Kit See pages 42-47 for comprehensive details  Shower Waste Pump P2 <i>NOT suitable for below tray drainage on concrete floors</i> See page 48-49 for comprehensive details  Shower tray Integral Pump P3 See page 50 for comprehensive details 	
<h1>KEY</h1>			

SYMBOLS:

Bulk/oversized item 

Made to order (see P200) 

Tel: 0800 917 0399

www.chilterninvadex.co.uk

Fax: +44 (0) 1869 365588

sales@chilterninvadex.co.uk

SHOWER TRAY SELECTOR - EASY ACCESS SHOWER TRAYS

Use this shower tray selector to choose the handing and tray size required. The key at the foot of the page explains the symbols used throughout this section.

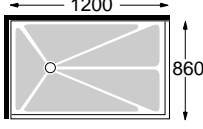
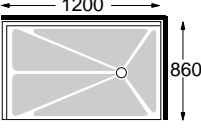
<p>ABBEYDALE 760</p> <div style="display: flex; align-items: center;"> <div style="margin-right: 20px;"> <p>G1 G1.1</p> <p>P2 *</p> </div>  </div> <p style="text-align: center; font-size: 24px; font-weight: bold;">LEFT HAND</p> <p style="font-size: 10px;">*Shower Waste Pump option suitable for timber joist situation with void - see p48-49.</p>	<p>ABBEYDALE 760</p> <div style="display: flex; align-items: center;"> <div style="margin-right: 20px;"> <p>G1 G1.1</p> <p>P2 *</p> </div>  </div> <p style="text-align: center; font-size: 24px; font-weight: bold;">RIGHT HAND</p> <p style="font-size: 10px;">*Shower Waste Pump option suitable for timber joist situation with void - see p48-49.</p>
---	--

ABBEYDALE 850

G1 G1.1

P2 *

NOT HANDED

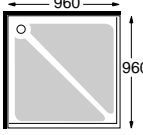

Rotate to suit

*Shower Waste Pump option suitable for timber joist situation with void - see p48-49.

ABBEYDALE 950

G1 G1.1

P2 *

NOT HANDED

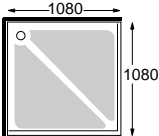

Rotate to suit

*Shower Waste Pump option suitable for timber joist situation with void - see p48-49.

ABBEYDALE 1050

G1 G1.1

P2 *

NOT HANDED

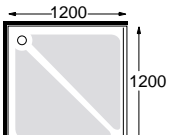

Rotate to suit

*Shower Waste Pump option suitable for timber joist situation with void - see p48-49.

DOVEDALE MK2

G2

P2

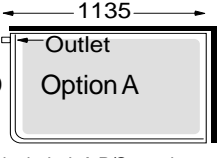

Option A

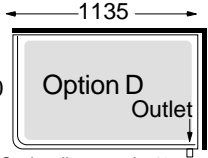

Option D

4-WAY
HAND

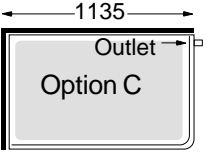



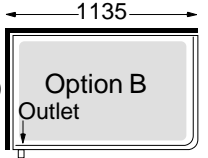

Option C

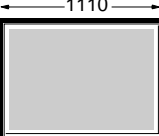
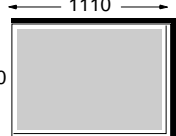

Option B

Notes: Trap not included. A P/S trap is suggested. Outlet diameter is 40mm.





<p>EDALE MK2</p> <div style="display: flex; align-items: center;"> <div style="margin-right: 20px;"> <p>G2</p> <p>P2</p> </div>  <p style="font-size: 24px; font-weight: bold;">LEFT HAND</p> </div> <p style="font-size: 10px;">Notes: Trap not included. A P / S trap is suggested. Outlet diameter is 40mm.</p>	<p>EDALE MK2</p> <div style="display: flex; align-items: center;"> <div style="margin-right: 20px;"> <p>G2</p> <p>P2</p> </div>  <p style="font-size: 24px; font-weight: bold;">RIGHT HAND</p> </div> <p style="font-size: 10px;">Notes: Trap not included. A P / S trap is suggested. Outlet diameter is 40mm.</p>
--	--

<p>GRAVITY WASTE OPTIONS</p> <p>Gravity waste (Invawaste)</p> <p>See pages 39-41 for comprehensive details</p> <p>Above floor waste outlet</p> <p>See page 41 for comprehensive details</p> <div style="display: flex; justify-content: space-around;">    </div>	<p>PUMPED WASTE OPTIONS</p> <p>Shower Waste Pump (box kit) P2</p> <p>NOT suitable for below tray drainage on concrete floors</p> <p>See pages 48-49 for comprehensive details</p> 
<h1>KEY</h1>	

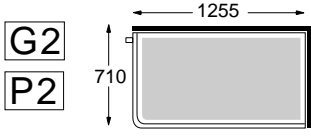
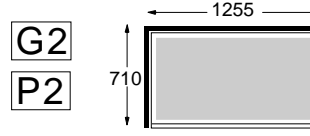
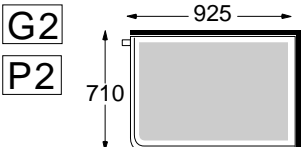
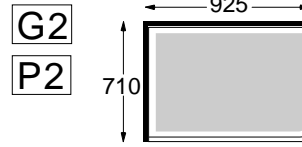
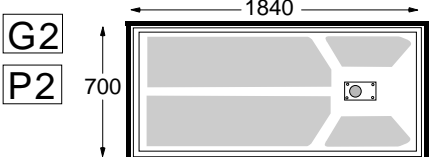
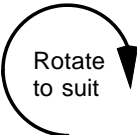
SHOWER TRAY SELECTOR - STEP-IN SHOWER TRAYS

Use this shower tray selector to choose the handing and tray size required. The key at the foot of the page explains the symbols used throughout this section.

BERRIEDALE		BERRIEDALE	
 <p>LEFT HAND</p>	 <p>RIGHT HAND</p>		
FERNDALE		FERNDALE	
 <p>LEFT HAND</p>	 <p>RIGHT HAND</p>		
HENLEYDALE			
 <p>NOT HANDED</p>	 <p>The Henleydale has a gravity waste, routable underneath the tray for convenience in installation. See page 91.</p>		

GRAVITY WASTE OPTIONS		PUMPED WASTE OPTIONS	
<p>Above floor waste outlet </p> <p>See page 41 for comprehensive details</p> 	<p>Shower Waste Pump </p> <p><i>NOT suitable for below tray drainage on concrete floors</i></p> <p>See page 48-49 for comprehensive details</p> 		
KEY			

SYMBOLS:

Bulk/oversized item 

Made to order (see P200) 

Tel: 0800 917 0399

www.chilterninvadex.co.uk

Fax: +44 (0) 1869 365588

sales@chilterninvadex.co.uk

GRAVITY WASTE (INVAWASTE)

G1

See p36-37 for Tray options



Gravity waste (Invawaste) suitable for timber floor construction

- Designed for use on a timber floor installation - sits within void in joists. 90mm shower trap with 50mm water seal and removable waste.
- For use with the following shower trays (gravity versions):
 - Sandwell range (Included in standard package)
 - Westdale range (Included in standard package)
 - Abbeydale range (Included in standard package)
- Removable top cover and removable inner cup for routine cleaning and maintenance

For further technical information go to the Shower trays & enclosure specification guide. This section starts on page 52.

code	product	Price
IDMIV02	Gravity waste (chrome) - replacement part	£30

GRAVITY WASTE DETAILS

Gravity waste (Invawaste) exploded view

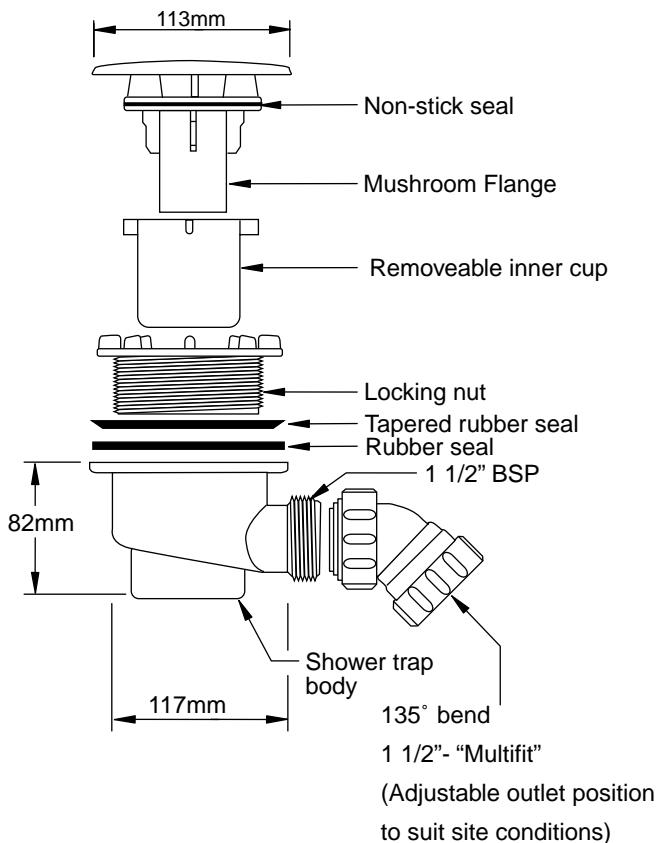

Gravity waste (Invawaste) plan view

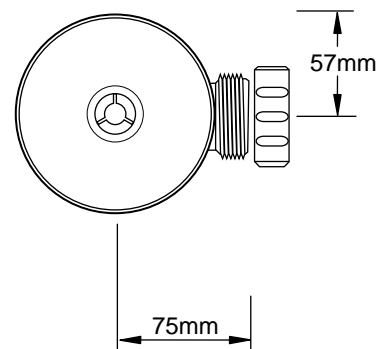

Gravity waste (Invawaste) cross section assembled

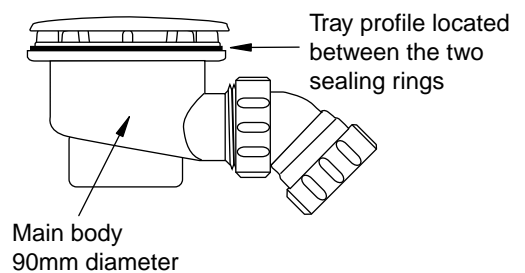

SYMBOLS:

Bulk/oversized item



Made to order (see P200)



Tel: 0800 917 0399

www.chilterninvadex.co.uk

Fax: +44 (0) 1869 365588

sales@chilterninvadex.co.uk

GRAVITY WASTE (INVAWASTE)

G1

See p36-37 for Tray options

TYPICAL CROSS SECTION THROUGH LEVEL ACCESS SHOWER TRAY - TIMBER FLOOR CONSTRUCTION

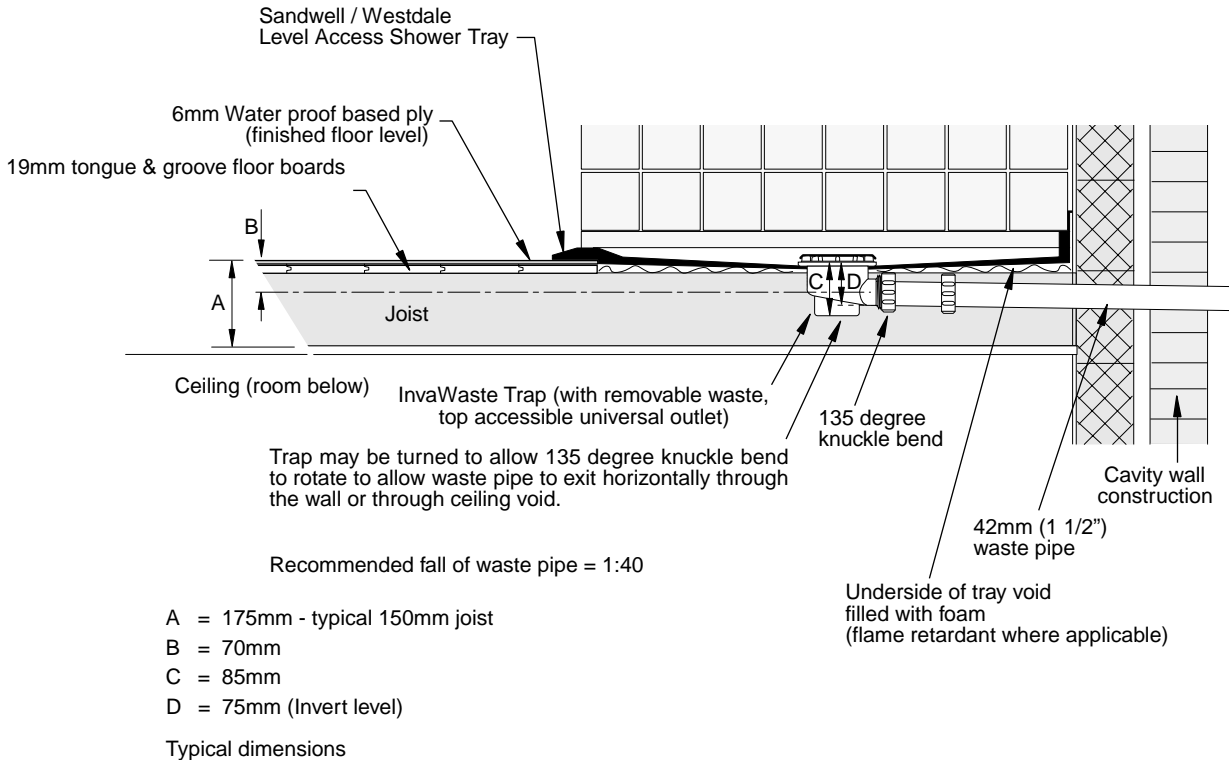

TYPICAL 3D SECTION THROUGH LEVEL ACCESS SHOWER TRAY - TIMBER FLOOR CONSTRUCTION

Example Illustration shows Westdale 655/760 shower tray installation (left hand waste outlet)
 Note position of waste over to left hand side

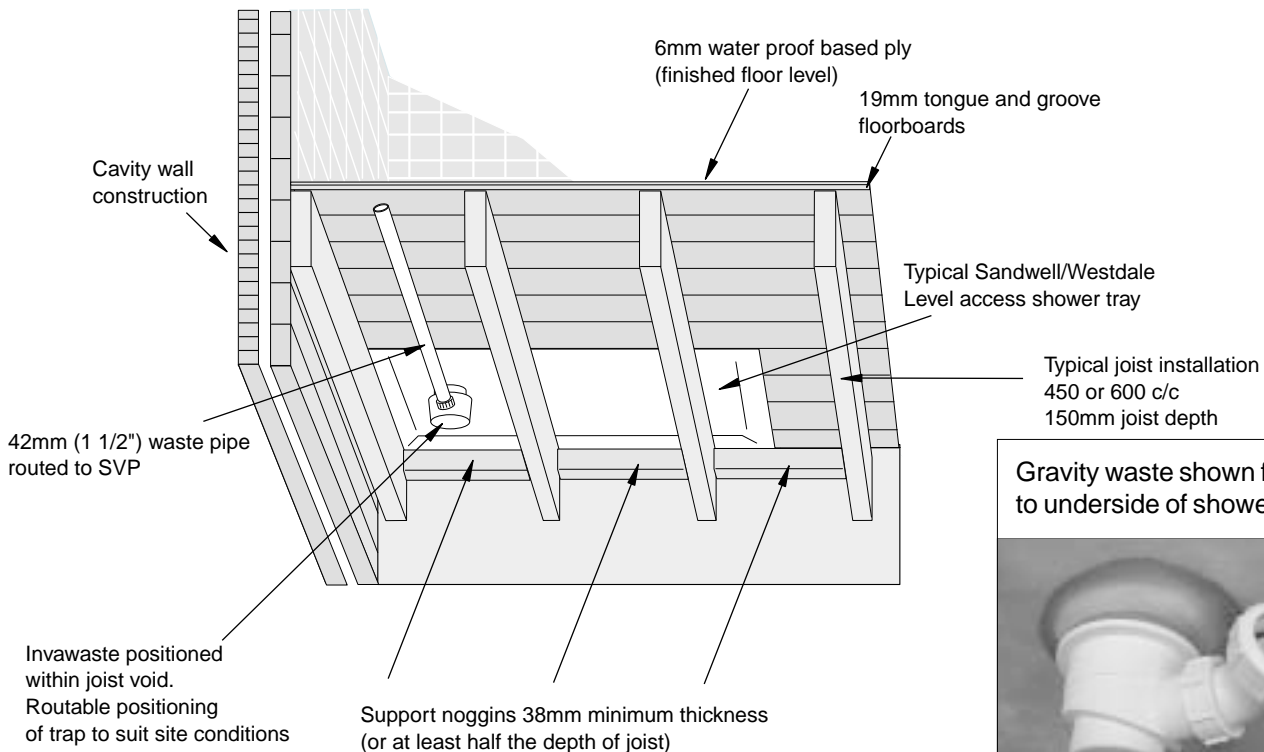

SYMBOLS:

Bulk/oversized item



Made to order (see P200)



Tel: 0800 917 0399

www.chilterninvadex.co.uk

Fax: +44 (0) 1869 365588

sales@chilterninvadex.co.uk

GRAVITY WASTE (INVAWASTE) VERTICAL OUTLET

G1.1
See p36-37 for
Tray options



Gravity waste (Invawaste) vertical outlet suitable for timber floor construction

- 90mm x 50mm Water seal with 1 1/2" Universal vertical outlet
- Overall height 108mm

code	product	Price
IDMIV04	Gravity waste - Vertical outlet	£30

GRAVITY WASTE DETAILS

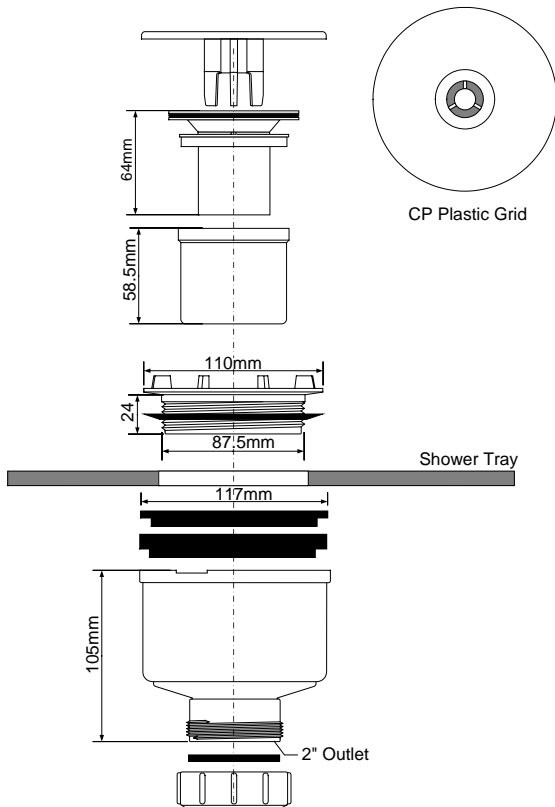

Gravity waste (Invawaste) vertical outlet exploded view

SHOWER TRAY - ABOVE FLOOR WASTE OUTLET

G2
See p37-38 for
Tray options



Edale MK2 pictured

Above floor waste outlet

- Above floor waste - no need to remove the floor as waste water discharge is above floor
- Left or right hand
- To be used in conjunction with a P/S trap

For further technical information go to the Shower trays & enclosure specification guide. See pages 40, 45-47.

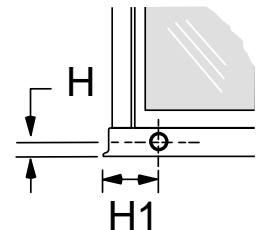

- Pipe diameter 1 1/2" (40mm)
- Projection 45mm for coupling up

H=40mm
H1=80mm

Outlet pipe height to centreline

SYMBOLS:

Bulk/oversized item



Made to order (see P200)



Tel: 0800 917 0399

www.chilterninvadex.co.uk

Fax: +44 (0) 1869 365588

sales@chilterninvadex.co.uk

PUMPED WASTE

P1

See p20 for
Tray options



Pumped waste suitable for concrete floor construction

- Designed for use on a concrete floor installation
- Ideal application when a shower tray installation is required and it is not possible to utilise a gravity version due to the depth of a typical gravity trap. The Whale waste outlet and pipework can be sited into the screed requiring only a 45mm depth, therefore unaffected a typical in-situ RC suspended floor and/or pre-cast concrete floor.
- For use with the following level access shower trays (pumped versions - low waste trays):
 - Sandwell range
 - Westdale range
- Can pump hair, gel, grit and other shower waste without blocking
- No filter in waste system - no cleaning required
- Valves integral to the pump prevent odours escaping from the drainage pipe
- Please contact the Technical Helpdesk for additional technical information

code	product	Price
IDWWP01	Whale automatic tray gully kit	£328
IDWWP03	Whale pump mixer conversion kit (Flow switch & 'Y' filter) required for shower mixer valve installation	£35

WASTE GULLEY DETAILS

For further technical information go to the *Shower trays & enclosure specification guide*. This section starts on page 52.

Waste Gully exploded view

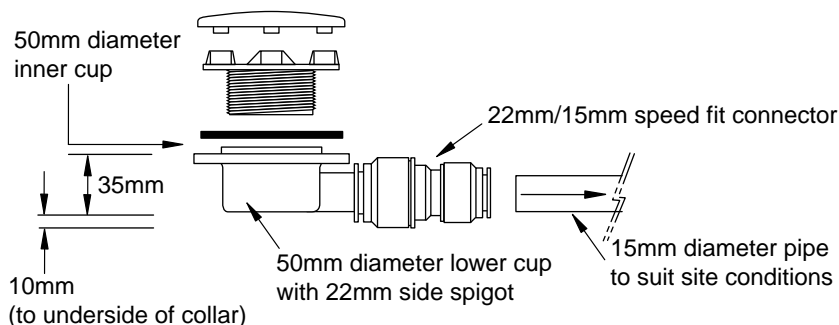

Important:

Dimension of 45mm (to underside of tray to be excavated to house waste collar)

Waste Gully Plan view

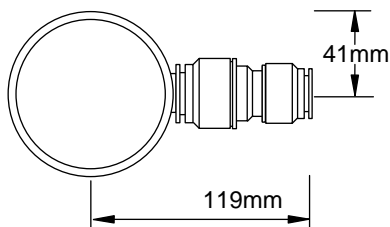

Waste Gully Cross section assembled

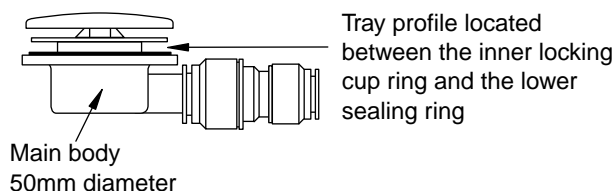

SYMBOLS:

Bulk/oversized item



Made to order (see P200)



Tel: 0800 917 0399

www.chilterninvadex.co.uk

Fax: +44 (0) 1869 365588

sales@chilterninvadex.co.uk

PUMPED WASTE

P1
See p20 for Tray options

TYPICAL CROSS SECTION THROUGH LEVEL ACCESS SHOWER TRAY - CONCRETE FLOOR CONSTRUCTION

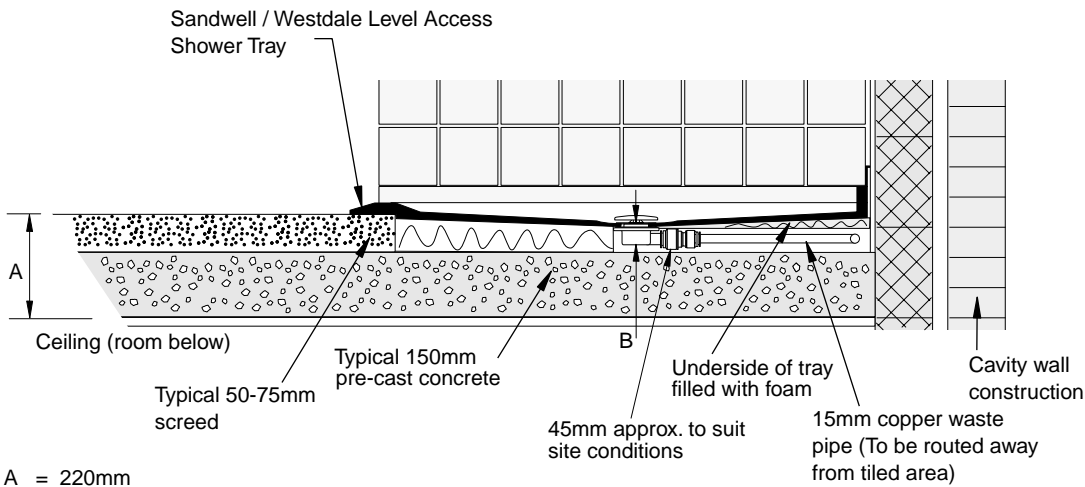

A = 220mm

B = 35mm (45mm to underside of main collar attachment)

(Typical dimensions)

NOTE. When installing use silicone on top of seal when positioning beneath the tray to ensure correct sealing.

Cross sectional view showing fitting of the Sandwell/ Westdale tray with the waste outlet

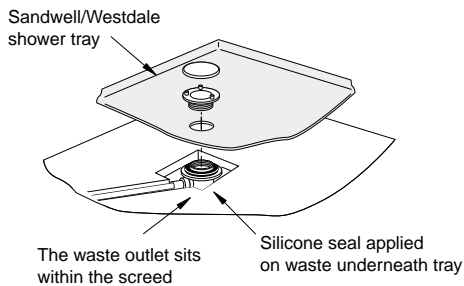

Pumped waste shown fitted to underside of shower tray

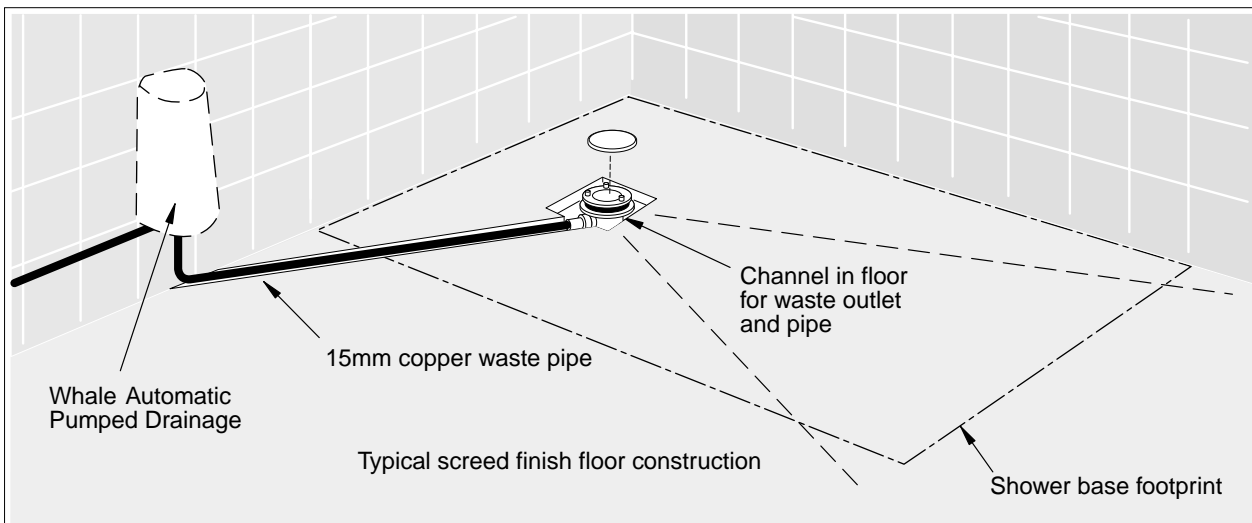

Notes:

Dashed lines indicate alternate routes (these may vary other than those shown, dependent on site conditions)

Tray to be recessed into the finished screed level - 20mm depth

(Full installation instructions available at www.chilterninvadex.co.uk or by contacting the Technical Department)

SYMBOLS:

Bulk/oversized item



Made to order (see P200)



Tel: 0800 917 0399

www.chilterninvadex.co.uk

Fax: +44 (0) 1869 365588

sales@chilterninvadex.co.uk

PUMPED WASTE

P1

See p20 for Tray options

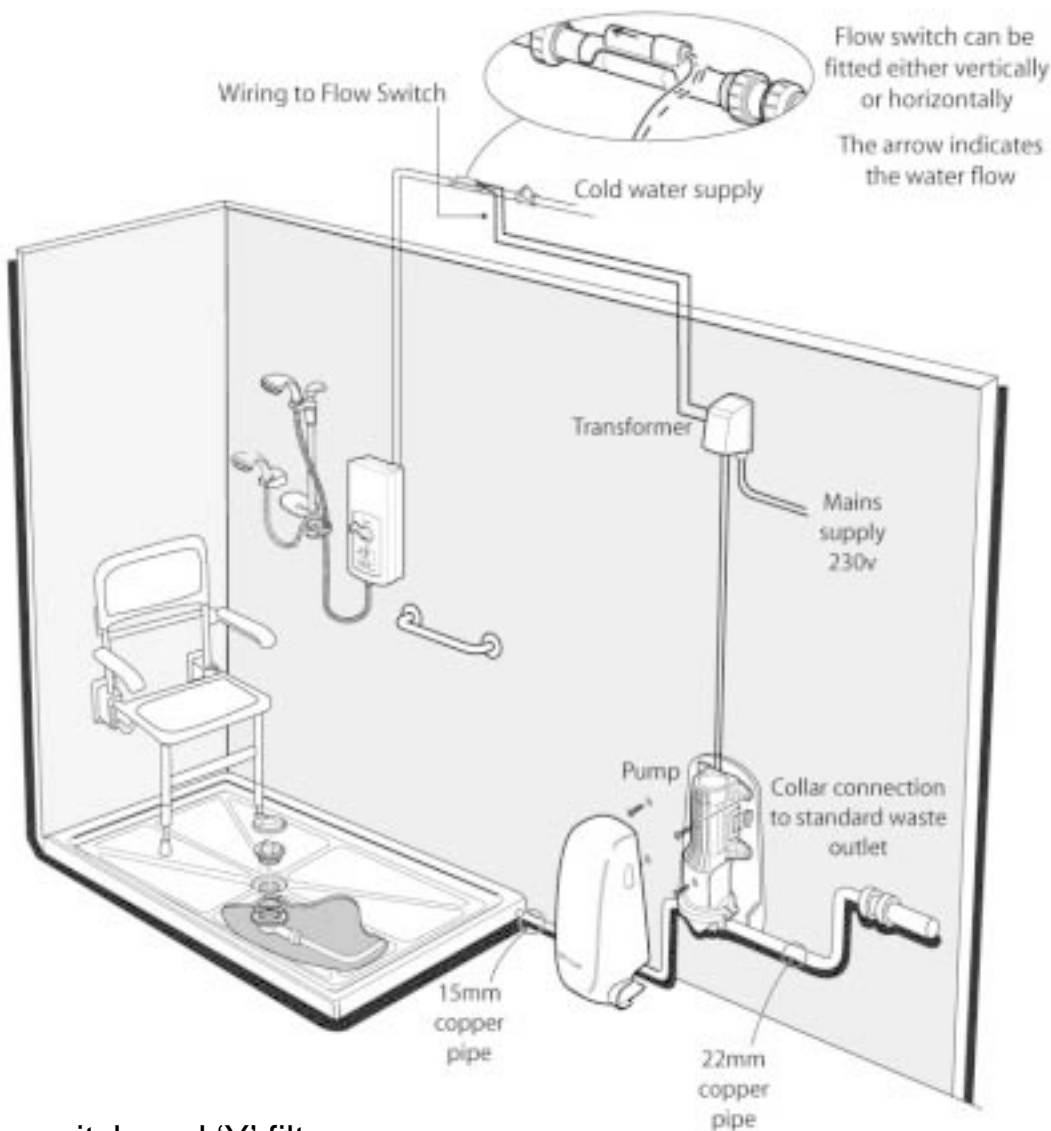

Flow switch and 'Y' filter

code	product	Price
IDWWP03	Whale pump mixer conversion kit (Flow switch & 'Y' filter) required for shower mixer valve installation	£35

Important:

An additional flow switch is required for a shower mixer valve installation connected into the hot water supply.

The switch may be positioned horizontally or vertically.

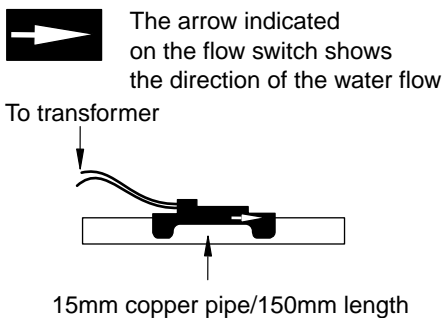

SYMBOLS:

Bulk/oversized item



Made to order (see P200)



Tel: 0800 917 0399

www.chilterninvadex.co.uk

Fax: +44 (0) 1869 365588

sales@chilterninvadex.co.uk

PUMPED WASTE

P1

See p20 for
Tray options



Digital smoothflow upgrade kit (upgrade to pump shown on p39)

- Almost silent when running - eliminates gulley suction noise
- Suits any existing Whale installation
- Flow rate of the pump adjusts automatically to changes in the shower flow rate
- Compensates for changes in the voltage from the mains electric supply
- 2 year warranty

code	product	Price
IDWWP06	Digital smoothflow upgrade kit	£368

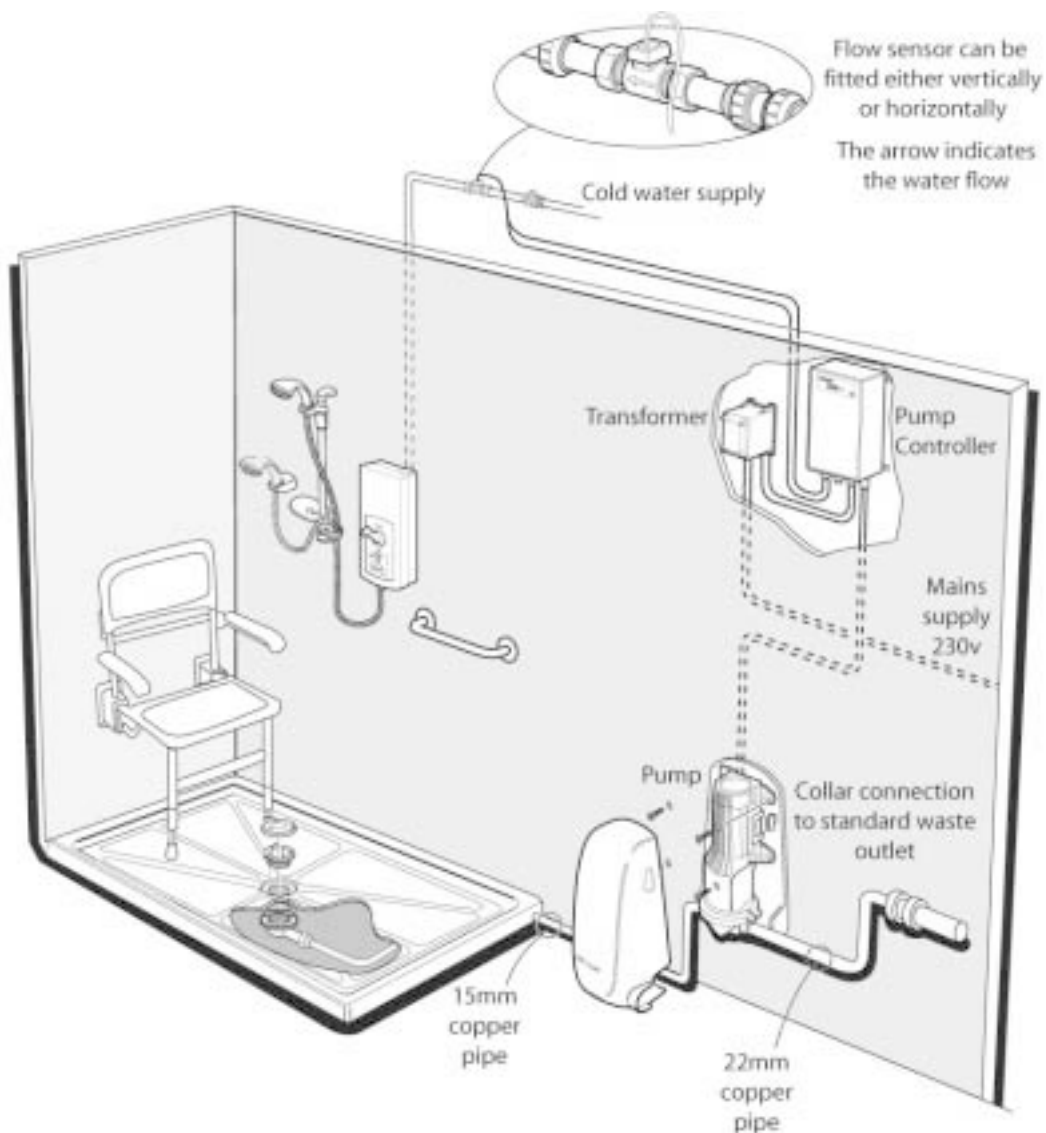

SYMBOLS:

Bulk/oversized item



Made to order (see P200)



Tel: 0800 917 0399

www.chilterninvadex.co.uk

Fax: +44 (0) 1869 365588

sales@chilterninvadex.co.uk

PUMPED WASTE

P1.1

See p36 for
Tray options



Pumped waste suitable for concrete floor construction

(Whale Instant Match™ for use with Mira Advance Extra)

- Designed for use on a concrete floor installation
- Ideal application when a shower tray installation is required and it is not possible to utilise a gravity version due to the depth of a typical gravity trap. The Whale waste outlet and pipework can be sited into the screed requiring only a 45mm depth, therefore unaffected a typical in-situ RC suspended floor and/or pre-cast concrete floor.
- Quiet gulley
- No set up required - plug and play
- No flow sensor/flow switch to fit
- For use with the following level access shower trays (pumped versions - low waste trays):
 - **Sandwell range**
 - **Westdale range**
- Can pump hair, gel, grit and other shower waste without blocking
- No filter in waste system - no cleaning required
- Valves integral to the pump prevent odours escaping from the drainage pipe
- Please contact the Technical Helpdesk for additional technical information

Important note: The Whale Instant Match™ pump/tray gulley kit can only be used with the Mira Advance Extra or Mira Advance Flex Extra. This is a different shower unit to the standard Mira, incorporating an internal shower flow sensor.

code	product	colour	Price
IDWWP07	Pump/Tray gulley kit for use with Mira Advance Extra shower unit. <i>Select the appropriate shower unit from the options shown below</i>	White	£360

Cross sectional views/dimensional information is shown on pages 39-40.



Mira Advance Extra

- Designed for use with the Whale Instant Match (shown above)
- Internal Shower Flow Sensor measures the flow rate going to the shower head. The Whale Instant Match automatically adjusts the pump speed in relation to the flow rate of the Mira Advance Extra Shower.
- Mira Advance ATL 9Kw electric shower has a push button stop and flow controls which are independent of the temperature dial
- Safe showering with precise thermostatic control for constant water temperature
- ATL - Adjustable Temperature Limit for added safety
- Instantly heats water to guarantee a hot shower every time
- New fittings - smooth slide bar with easy glide operation
- Tactile push button flow controls for ease of use
- 2 Year guarantee
- RNIB approved
- BEAB caremark

*Mira Advance Flex Extra
Illustrated*

Mira Advance Flex Extra has the same features as the Mira Advance Extra but features an extended temperature control lever, 2m hose and additional handset holder for flexible showering heights.

code	product	Price
IDWMA01AE	Mira Advance Extra Thermostatic shower unit	£354
IDWMA05AE	Mira Advance Flex Extra Thermostatic shower unit	£384

SYMBOLS:

Bulk/oversized item



Made to order (see P200)



Tel: 0800 917 0399

www.chilterninvadex.co.uk

Fax: +44 (0) 1869 365588

sales@chilterninvadex.co.uk

PUMPED WASTE

P1.1

See p36 for Tray options

Whale Instant Match™ for use with Mira Advance Extra

The Whale Instant Match™ automatically adjusts the pump speed in relation to the flow rate of the Mira Advance Extra Shower, as illustrated below.

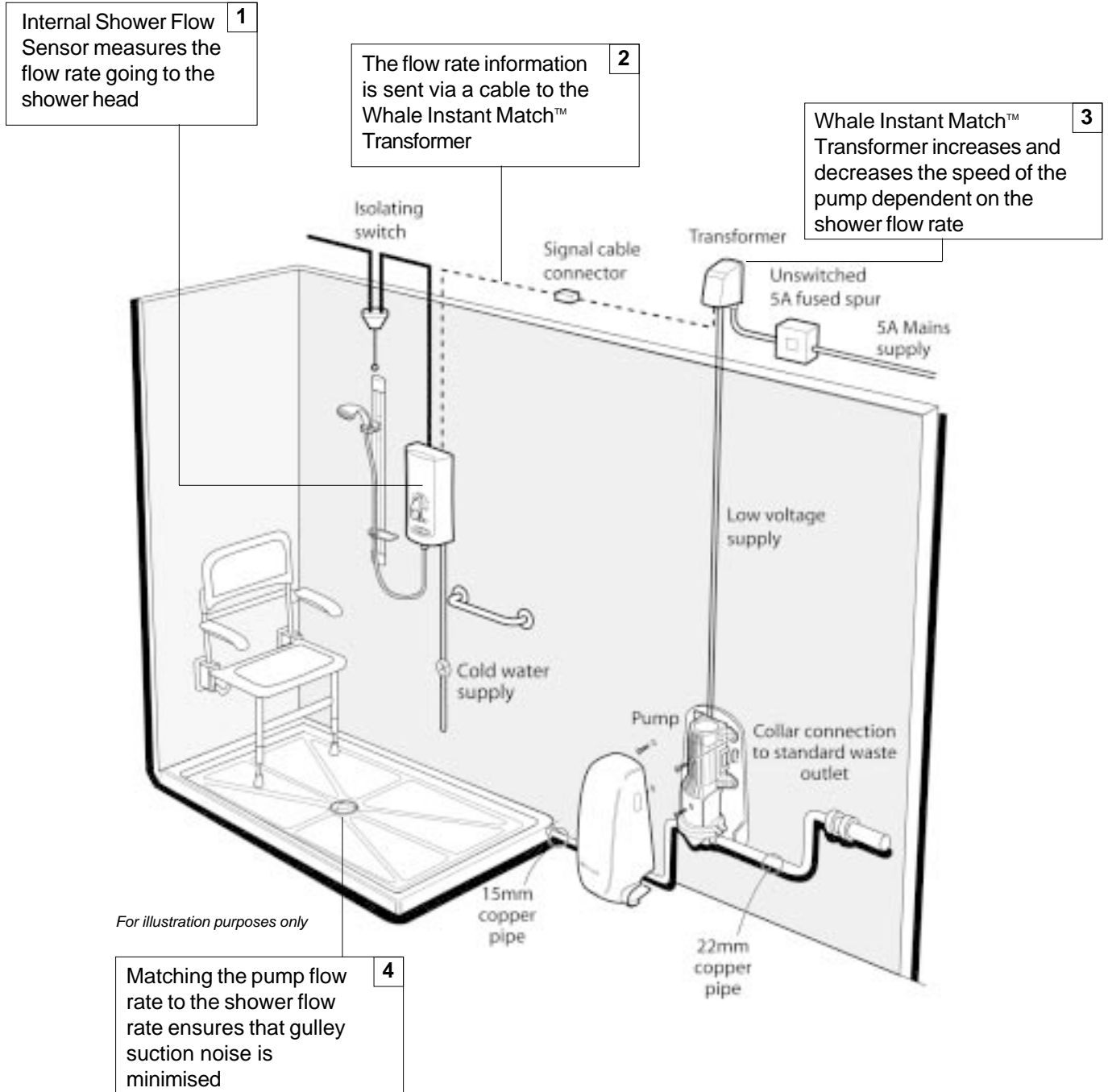

WHALE INSTANT MATCH™ KEY BENEFITS

- Quiet gulley
- No set up required - plug and play
- No flow sensor/flow switch to fit

SYMBOLS:

Bulk/oversized item



Made to order (see P200)



Tel: 0800 917 0399

www.chilterninvadex.co.uk

Fax: +44 (0) 1869 365588

sales@chilterninvadex.co.uk

SHOWER WASTE PUMP

P2

See p36-38
for Tray options



Kit illustrated

Shower waste pump kit

- Where access to drainage is difficult a shower waste pump allows waste water to be pumped away, without the need to rely on a gravity fall
- Suits all Chiltern Invadex shower trays (except Cardale which comes with its own pump) as shown below
- Quiet and filterless low voltage pump (12v)
- Simple to install and maintain
- Audible alarm to indicate blockages
- Pump lid snaps on and is easily removed for routine cleaning and maintenance

Shower waste pump kit compatibility selector



Shown recessed



Shown surface mounted

	TRAY DESCRIPTION	TYPICAL TIMBER FLOOR CONSTRUCTION	TYPICAL CONCRETE/SCREED FLOOR CONSTRUCTION
LEVEL ACCESS	Sandwell MK3 655	✓	×
	Sandwell MK3 760	✓	×
	Westdale 655	✓	×
	Westdale 760	✓	×
	Westdale 850	✓	×
	Westdale 1000	✓	×
	Cardale MK2	Supplied with integral pump	Supplied with integral pump
EASY ACCESS	Abbeydale 760	✓	×
	Abbeydale 850	✓	×
	Abbeydale 950	✓	×
	Abbeydale 1050	✓	×
	Dovedale MK2	✓	✓
	Edale MK2	✓	✓
STEP-IN	Berriedale	✓	✓
	Ferndale	✓	✓

code	product	Price
115-00001	Standard Pump Kit, single unit	£395
115-00001	Standard Pump Kit, box of 5 units	each £390
115-00001	Standard Pump Kit, box of 10+ units	each £385

Package includes wiring block - which controls the pump manually, pump and necessary fittings & connections to the above floor outlet or Invawaste - see pages 39-40.

Technical Information

Notes: Flexi-pipe supplied (40mm) for flow into box. Flow outlet from box is 22mm

Maximum 15 litres/min drainage (dependent on type of shower tray)

Case constructed from white flame retardant ABS

Side and end elevation

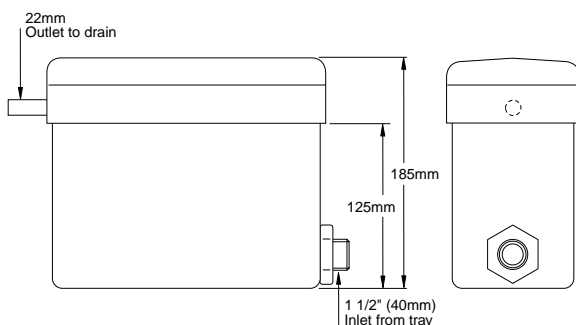

Plan elevation

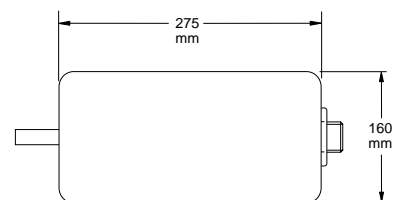

SYMBOLS:

Bulk/oversized item



Made to order (see P200)



Tel: 0800 917 0399

www.chilterninvadex.co.uk

Fax: +44 (0) 1869 365588

sales@chilterninvadex.co.uk

SHOWER WASTE PUMP

P2

See p36-38
for Tray options

Technical Information

For further technical information go to the Shower trays & enclosure specification guide. This section starts on page 52.

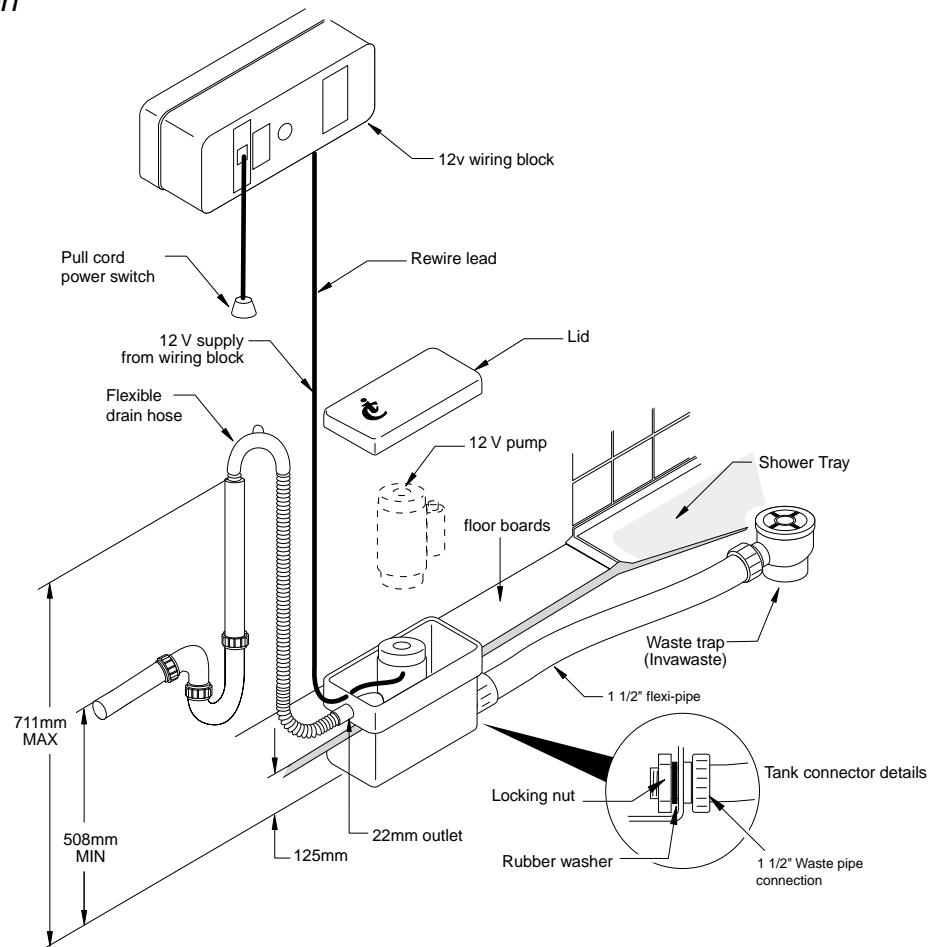

Notes:

Typical stack detail, waste hose running into standpipe with P-trap. Waste pipe laid is suitable gradient before running into hopper head, gully or SVP.

Please note:

Chiltern Invadex can supply an automatic version of the Shower Waste Pump kit shown above. Please contact the Technical Helpdesk for assistance.

Typical installation utilising washing machine type waste

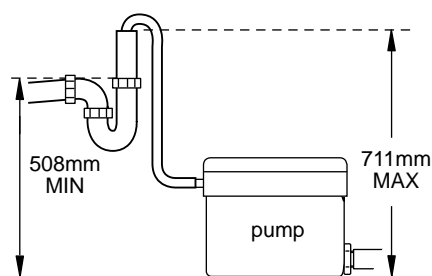

Maximum height from base of box to top of standpipe 711mm (28") down to a minimum height of waste discharge 508mm (20") will give maximum efficiency of the pump, with a suitable down gradient slope.

SYMBOLS:

Bulk/oversized item



Made to order (see P200)



Tel: 0800 917 0399

www.chilterninvadex.co.uk

Fax: +44 (0) 1869 365588

sales@chilterninvadex.co.uk

SHOWER TRAY INTEGRAL WASTE PUMP

P3

See p36 for
Cardale MK2
Tray options



Shower tray Integral waste pump (Included as standard on Cardale MK2)

- Where access to drainage is difficult a Shower tray Integral waste pump allows waste water to be pumped away, without the need to rely on a gravity fall
- Supplied complete with cover, easily removed for routine cleaning and maintenance
- Quiet and filterless low voltage pump (12v)
- Simple to install and maintain
- Audible alarm to indicate blockages
- Stud wall minimum width - typically 75mm minimum to house 40mm stack pipe.



- Cardale MK2 shown left with 12v wiring block, integral pump, rewire lead and cover

For further technical information go to the Shower trays & enclosure specification guide (page 57)

Technical Information

Typical installation utilising washing machine type waste

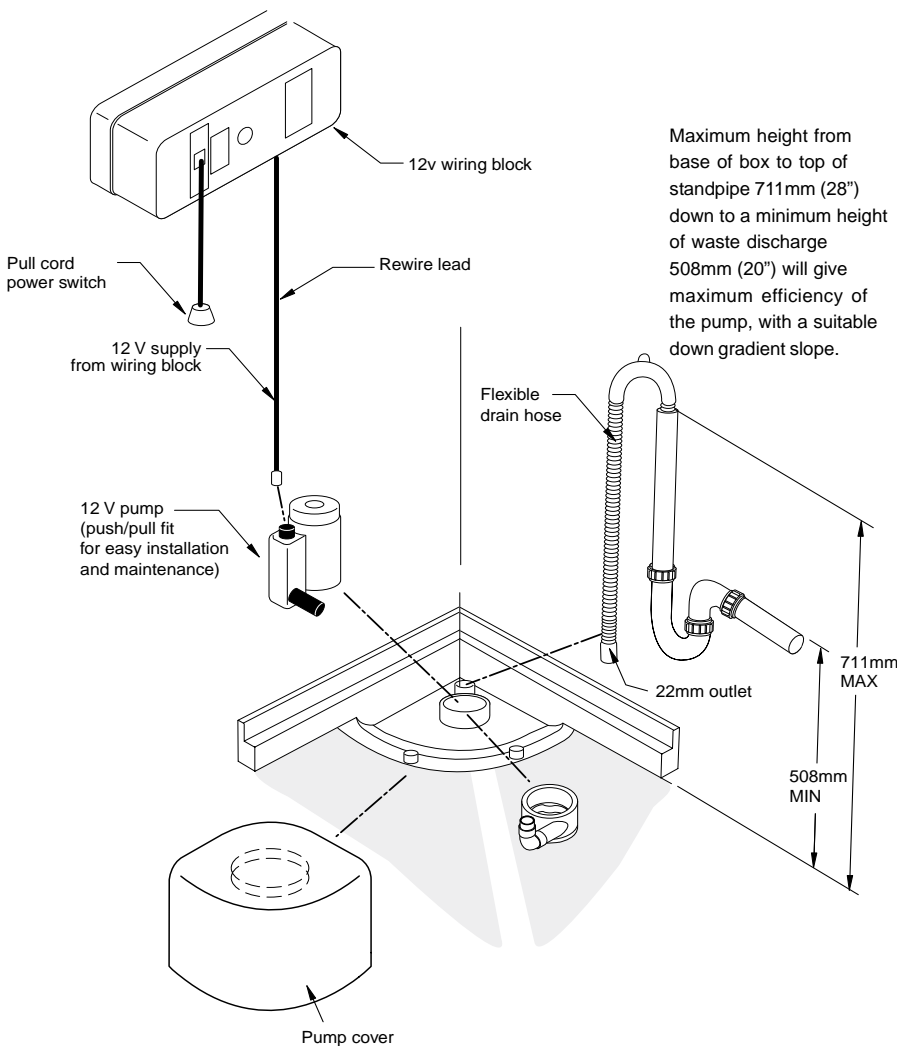

Maximum height from base of box to top of standpipe 711mm (28") down to a minimum height of waste discharge 508mm (20") will give maximum efficiency of the pump, with a suitable down gradient slope.

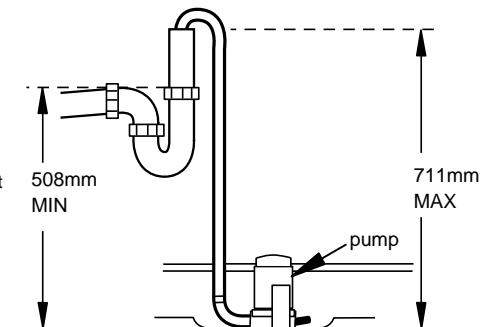

Notes:

Typical stack detail, waste hose running into standpipe with P-trap. Waste pipe laid to suitable gradient before running into hopper head, gully or SVP.

SYMBOLS:

Bulk/oversized item



Made to order (see P200)



Tel: 0800 917 0399

www.chilterninvadex.co.uk

Fax: +44 (0) 1869 365588

sales@chilterninvadex.co.uk