



British Manufacturer

Showering & Bathing Range

Accessible Bathing Solutions



Chiltern Invadex (UK) Limited Unit 6C Thorpe Drive, Banbury, Oxfordshire OX16 4UZ
01869 365500 sales@chilterninvadex.co.uk www.chilterninvadex.co.uk

Brochure Contents

Page	Category
1-4	Cubicles
5-8	Wet Floor
9	Shower Trays
10-12	Level Access Trays
13-14	Easy Access Trays
15-18	Automatic Toilet
19-21	Accessories
22	Installation & Maintenance



Cubicle Range

The Chiltern Invadex range of shower cubicles have been specifically designed to provide an affordable showering solution for those who are unable to access a conventional bathroom.

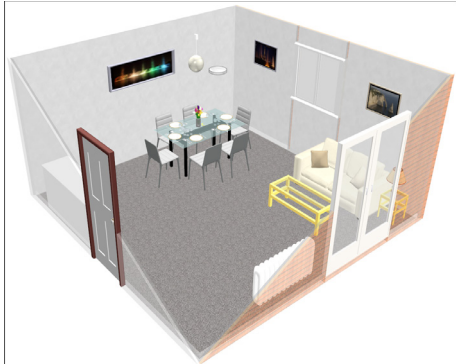

Developed as a freestanding unit requiring no tiling or excavation, cubicles can be installed in virtually any room and are perfect for use in downstairs living area adaptations.



Designed to be installed in just one day (subject to access to services) and easily dismantled for re-use/re-location, the Chiltern Invadex cubicle range is ideal for permanent or temporary use.

With a variety of sizes, there is a cubicle to fit neatly into almost any room.

The range consists of six cubicles;

Three shower cubicles

Three shower toilet cubicles



Cubicles can be recessed into the floor to create level access. This requires floor excavation and is suitable for more permanent installations.

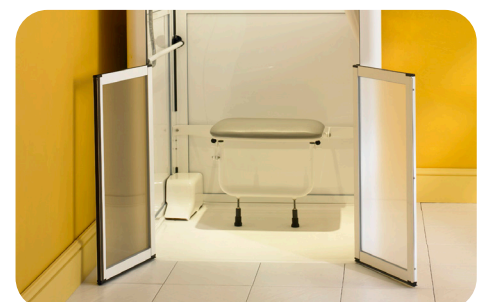







Shower Cubicles



Model 100

Features and Options

Shower cubicles are available with numerous configuration options to suit the user and environment.

-  Pumped or gravity waste
-  Half height carer panels
-  Single, bi-fold and tri-fold door option
-  LED light and fan options
-  Cubicle seats with various seat options (refer to page 4 for details)
-  Removable access ramp (11° gradient)
-  Horizontal & vertical grab rails





Shower Toilet Cubicles



Model 100

Features and Options

As the shower cubicle range with the addition of;

-  Full size vitreous china WC pan and white seat with lid
-  WC flush lever flush as standard, button flush on request
-  High level external cistern
-  Plastic basin with plug (filled via shower head)
-  Optional porcelain sink complete with lever taps, plug and waste trap (must be fitted at time of manufacture)

Accessories

Electric and mixer showers
(see page 21)



Cubicle seating
(see page 4)



SaniPRO XR Up macerator
(see page 21)



Size options

The range consists of three size options, three front entry cubicles, each available as a shower or combined shower WC cubicle.

All ramps have an 11° gradient.

Shower Cubicles

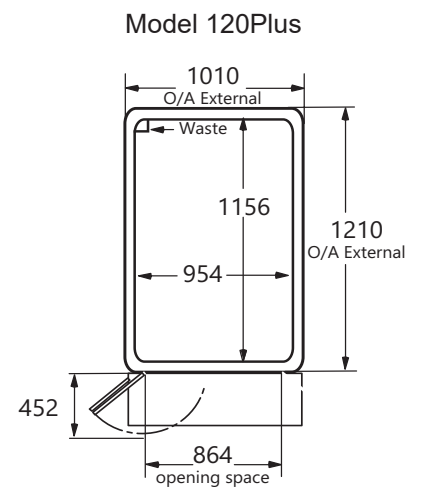
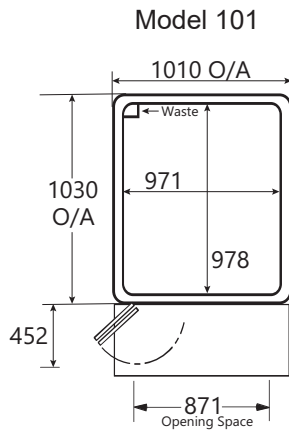
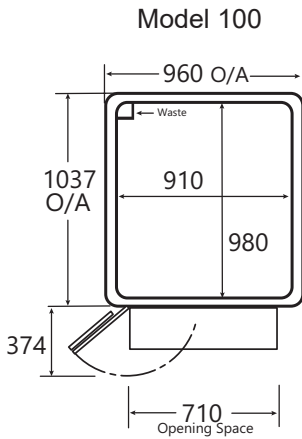

Shower Toilet Cubicles

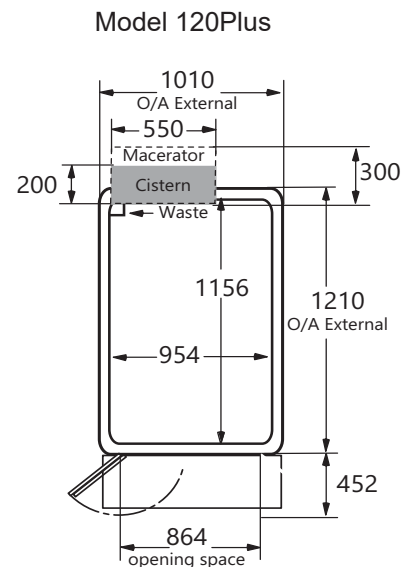
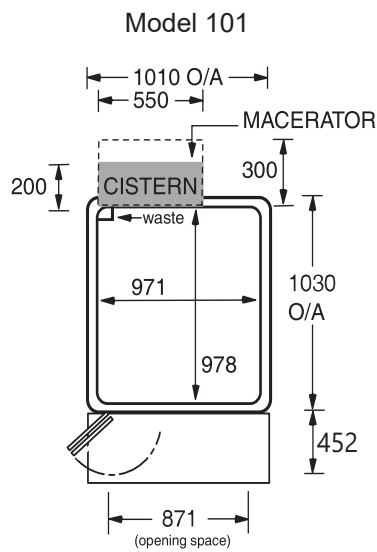
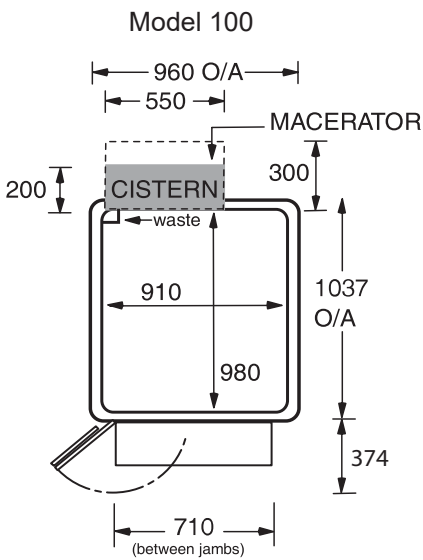

Shower Cubicle Seats (not suitable for use in shower toilet cubicles)

A number of shower seats have been produced to complement the shower cubicle range, height of the seat is set at time of manufacture to suit individual user needs.

Fold Up Seats

The fold up seat range folds neatly against the cubicle wall when not in use, allowing cubicles to be utilised by multiple users with varying abilities.

Fold up seats can be used in any of the side and front entry shower cubicles.

Vinyl seats

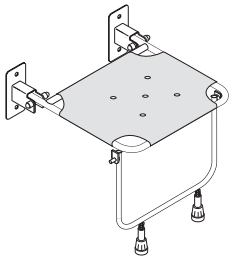

Manufactured in grey reinforced PVC, vinyl seats provide a sturdy and cost effective seating solution.

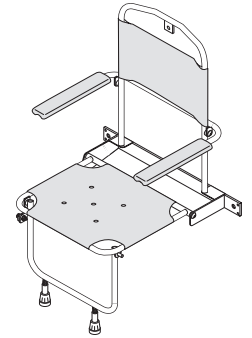



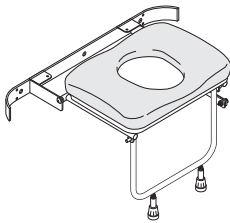



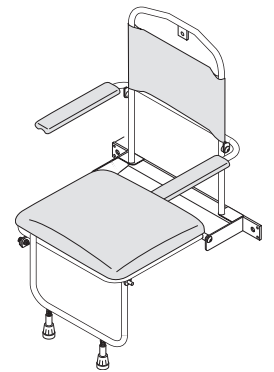

Padded seats

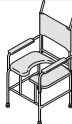

Padded seats are upholstered for added comfort, they are available as shown or with the addition of a horseshoe or full ring aperture (shown left) to assist bathing.



Shower Chair Compatibility

Cubicle Model	Chair Type							
	AquaMaster				TransAqua			
	A02	A06	A08	A11	TA18AP	TA21AP	TA18SP	TA21SP
Front entry 100								
Front entry 101	✓	✓	Standard door only	✗	✓	✓	✗	✗
Front entry 120Plus*	✓	✓	✓	✓	✓	✓	✓	✓

*120Plus can be used with certain Tilt in Space models

Please refer to shower accessories on page 19 for full chair details.

Easidec Wet Floor Shower System

The Easidec range provides a contemporary wet floor bathroom styled for modern living.

The wet floor formers provide a true level access showering platform which incorporates the perfect gradient to enable efficient water drainage. Formers are suitable for installation within both timber and concrete floors.

Manufactured using high glass content SMC and a rigid waffle design, the 22mm Easidec former is able to withstand upto 300kg (47 stone) without the need for under boarding.



Standard trays are designed to be covered with a non slip vinyl floor covering. Where tiling is the preferred option, the tray can be supplied with a choice of waterproof membrane.

Available in 7 tray sizes and with upto 15 standard door options, there is an Easidec to suit almost any situation.



Tray Options

Easidec 1

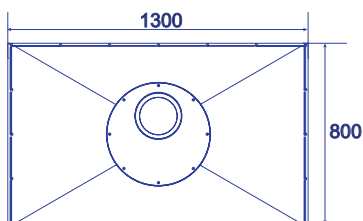

Easidec 2

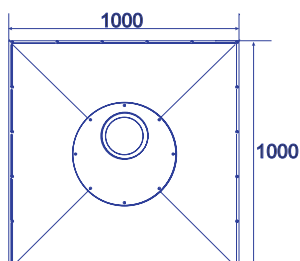

Easidec 3

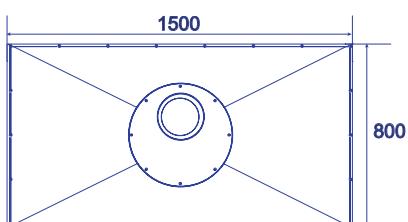

Easidec 4

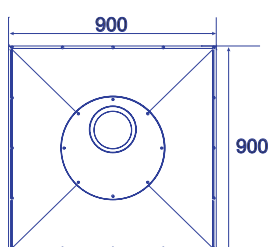

Easidec 5

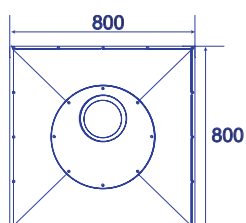

Easidec 6

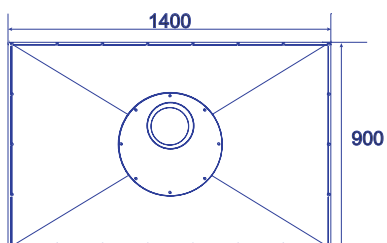

Easidec 7

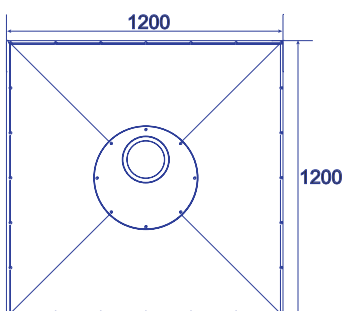

Easily trimmable up to solid surround with a standard hand saw.

Waste Options

To assist with ease of installation the Easidec system features a 360° rotating drain plate to avoid underfloor obstructions.



Each former is supplied with a gravity waste and trap as standard.

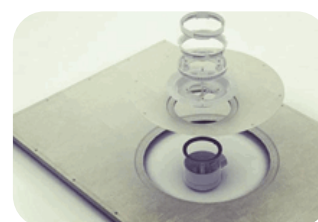

A pumped waste option which utilises a Whale pump to assist with efficient water drainage on concrete and floating floors is available.



Features

- Adjustable pump speed settings designed to suit Electric and Mixer* Shower installations
- Integrated flow switch and filter
- Quiet gulley - free Whale Whisper wet floor gulley included
- High performance. Draws 3 metres from gulley. Lifts 0.5 metre. Pumps up 1 metre
- Flexible installation options. Small pump and transformer will fit into tight spaces – e.g. airing cupboard

* A second flow switch is required for mixer installations

Door Options

Enclosures are provided with wet floor bolsters as standard, these are radiused wall channels which mirror the curve of a wet floor cove former to ensure maximum water retention.

Option 1

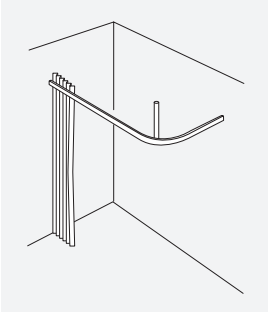

To suit all Dec options

Option 2

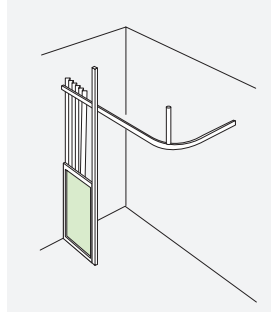

To suit all Dec options

Option 3

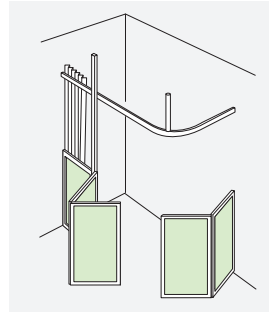

To suit Dec options;
1, 3 & 6

Option 4

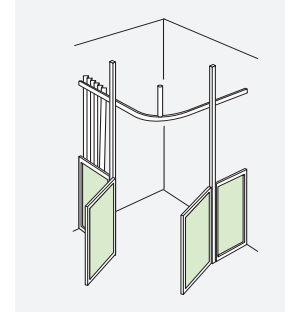

To suit Dec options;
2, 4 & 7

Option 5

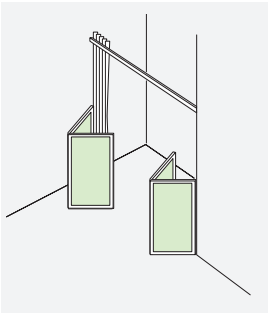

To suit Dec options;
1, 3, 6 & 7

Option 6

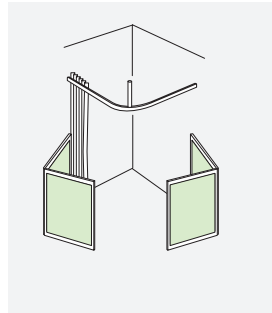

To suit all Dec options

Option 7

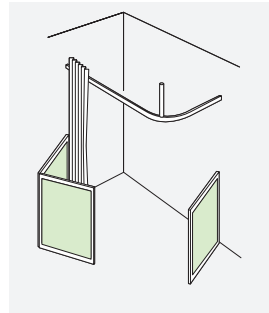

To suit Dec options;
1, 3 & 6

Option 8

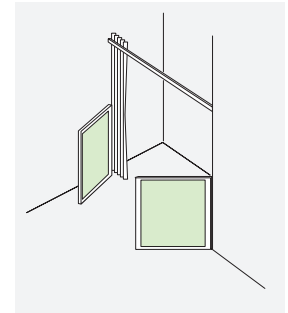

To suit Dec options;
1, 2, 3, 6 & 7

Option 9

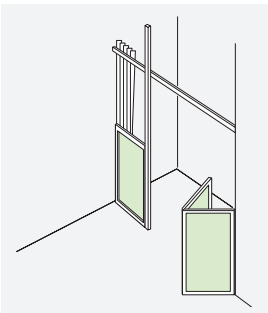

To suit Dec options;
1, 3 & 6

Option 10

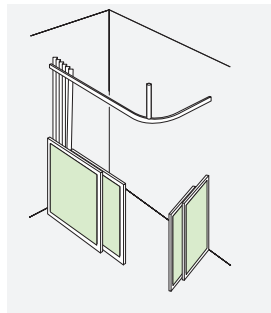

To suit all Dec options

Option 11

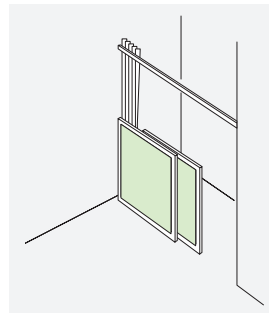

To suit all Dec options

Option 12

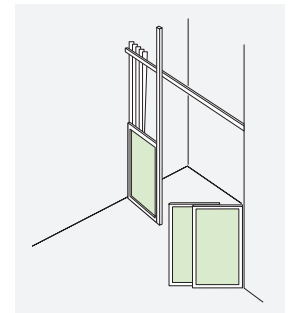

To suit Dec options;
1, 3, 6 & 7

Option 13

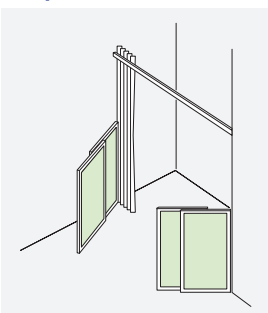

To suit Dec options;
1, 3, 6 & 7

Option 14

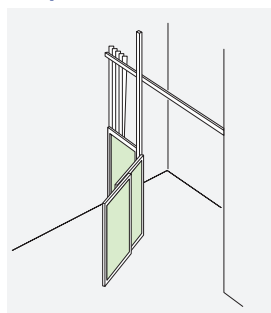

To suit Dec options;
1, 3, 6 & 7

Option 15

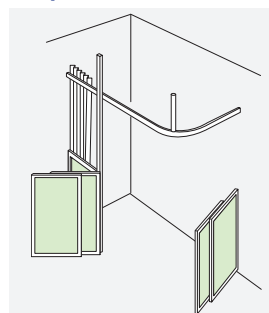

To suit Dec options;
1, 3, 6 & 7

Installation

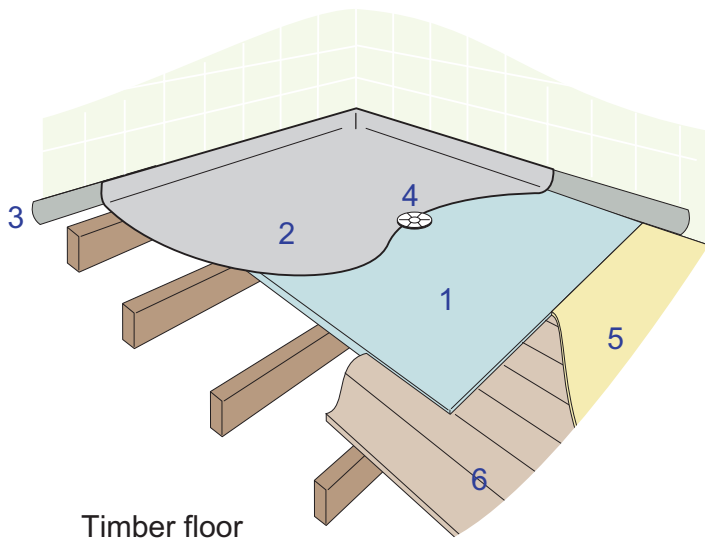

Timber floor

The floorboards are removed and the Easidec is permanently fixed to the joists. The floor finishes level with the edges of the Easidec and the floor then covered with an anti-slip flooring.

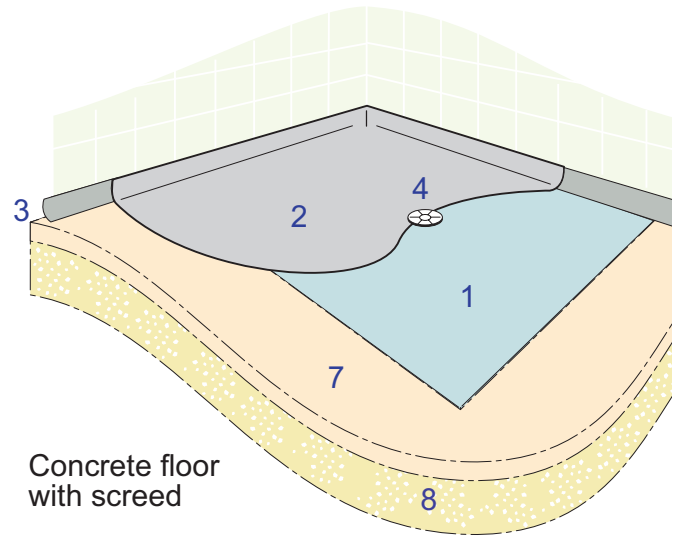

Concrete floor with screed

The Easidec is let into the screed on a concrete floor. Following installation of pipework it is then bedded down to sit level with the existing floor. The whole floor is then covered with anti-slip flooring.

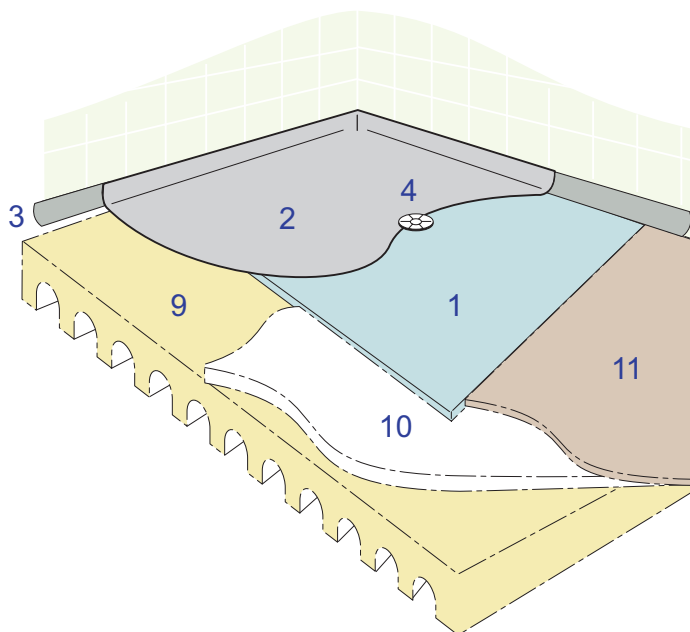

Floating Floor

Illustration shows chipboard flooring and insulation which must be removed. To prevent chipboard movement the edges of the flooring must be supported with timber. The supports carry the Easidec which is eventually fixed to it after plumbing is completed. The whole floor is then covered with anti-slip flooring.

KEY

1. Easidec
2. Altro Aquarius or similar vinyl floor covering
3. 35mm cove former
4. Waste adapter & trap (timber floor), wet floor gulley (concrete and floating floors)
5. Plywood (where needed to support bariatric users)
6. 19mm tongue & groove floorboarding
7. Typical 50mm screed
8. Typical 150mm precast concrete
9. Typical one way spanning ribbed, troughed or waffle floor/typical screed
10. Insulation
11. Chipboard support

Shower Trays

The Chiltern Invadex shower tray range consists of a range of level and easy access trays with enclosures to suit.

The range includes both above and below floor tray options to suit timber and concrete scenarios.



Manufactured from glass reinforced plastic, trays are strong and resilient and feature a non slip surface requiring no additional safety matting.

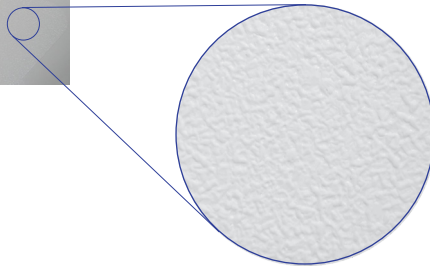

Each tray features a tiling upstand which enables a seamless, watertight seal around the base of the tile/panel and tray joint.

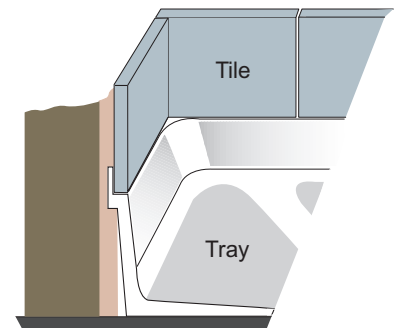

Enclosures

Enclosures are manufactured from white powder coated aluminium sections and durable obscured PETg panels.

Slide and fold and trifold doors are fitted with rise and butt hinges which allows the doors to rise and glide smoothly across the tray. This also provides flexibility through 180 degrees of rotation.



Level Access

Our level access tray range comprises of three trays, each available in a choice of width to suit the room constraints.

The Sandwell and Westdale are gravity trays which can, where required, be used with a Whale pump to provide an efficient pumped waste tray. The Cardale tray includes an integral pump and has been designed to be installed on a concrete floor with the minimum of structural disruption.

Level access trays have a graduated 17mm threshold which is suitable for both ambulant and shower chair users. For a true level access bathing environment a wet floor former should be considered see pages 5-8 for details.

Sandwell

Designed as a bath replacement tray, the Sandwell is 1850mm long and is available in 655mm and 760mm internal widths.

The tray features an integral drying area which can be trimmed to 1200mm using a hard point hand saw.



Left Hand



Right Hand

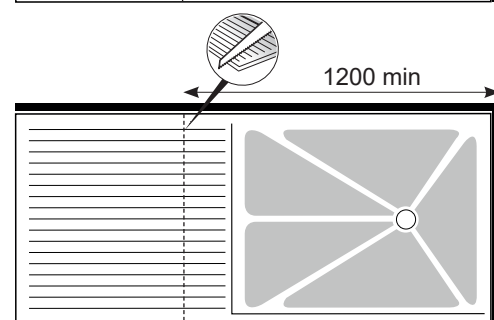
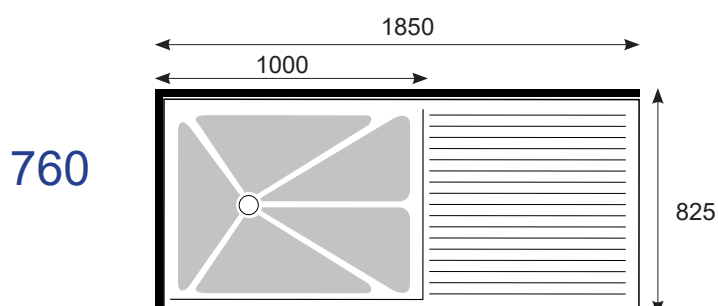
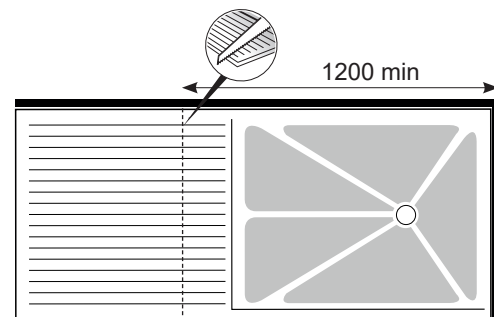
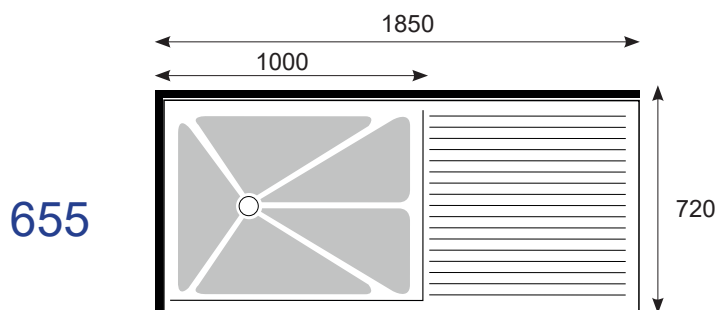

Westdale

The compact Westdale is available in three tray sizes.

Provided with a gravity waste and trap as standard, an efficient pumped waste can be obtained utilising a Whale pump kit.



Left Hand

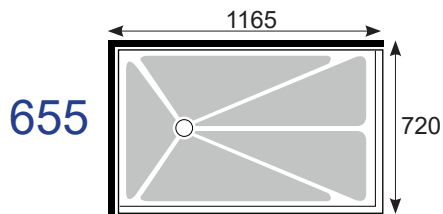

Right Hand

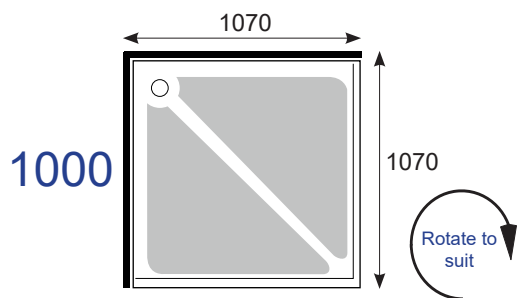
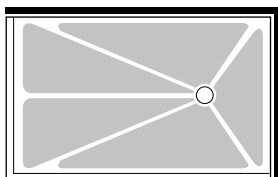
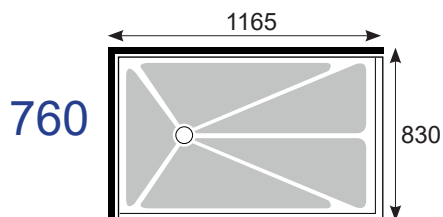
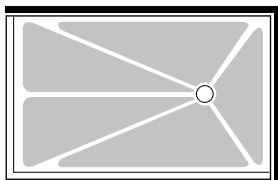

Cardale



The Cardale is a pumped waste system incorporating an integral pump within the tray.

Designed primarily with a concrete floor in mind, the tray can be installed with minimal disruption, requiring removal of a limited amount of the screed layer.

Available with left or right hand waste option, the tray comes complete with a tri-fold door enclosure, pump, wiring block and removable pump cover.

Left Hand

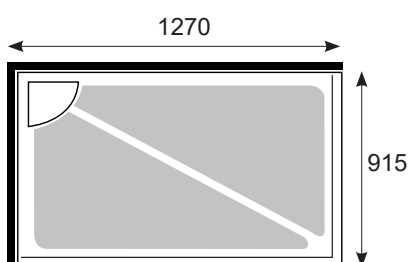

Right Hand

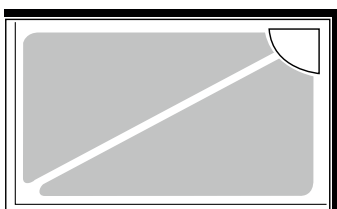

12v integral waste pump with removable cover to facilitate cleaning and maintenance

Installation

The Chiltern range of level access trays are easy to fit and have been designed to include a tray edging strips to create a water tight seal between the tray and a non-slip safety flooring.

Sandwell & Westdale Trays

Sandwell and Westdale trays are supplied with a gravity waste and trap (McAlpine STW1-R). Pumped waste can be used in conjunction with the relevant shower pump. The recommended pump is a Whale Gulper 320, which is available on request to suit concrete floor installations.

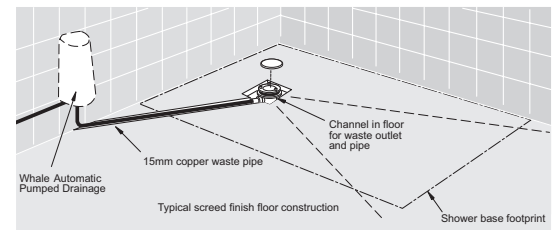
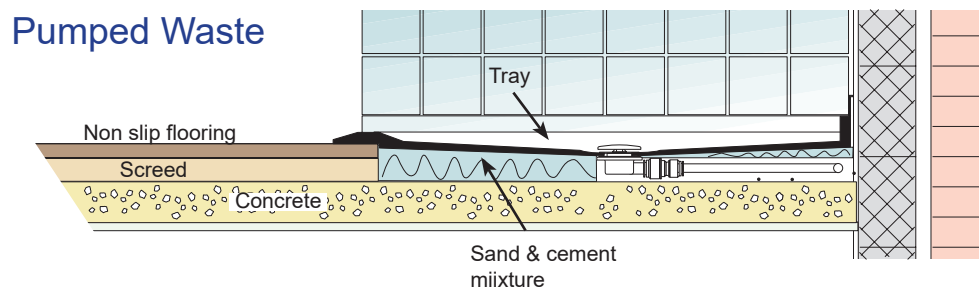
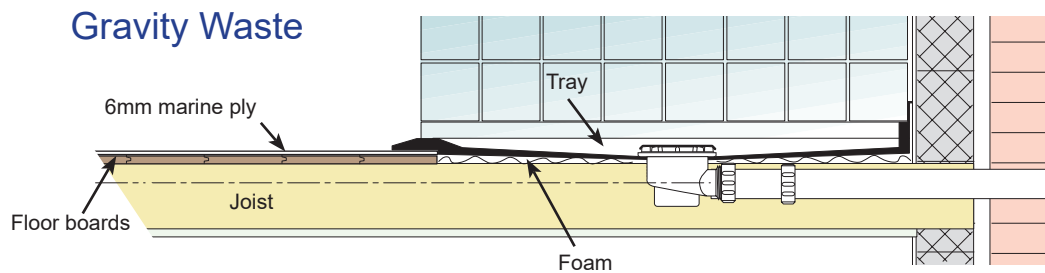

Cardale Tray

The Cardale pump system utilises a simple washing machine style waste stack. The waste need only be a 40mm plastic pipe fitted with a trap before it goes out into the main stack.

The hose and wiring to the 12v pump is hidden behind a stud wall.

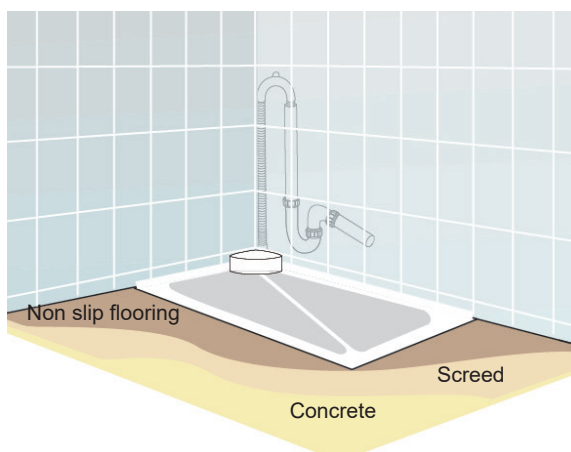

Excavation of the concrete floor is kept to a minimum. The pump socket requires a 220x220 35mm trench within the screed.

The tray requires 660x430 removal of the screed to a depth of just 5mm to accommodate the gradient required for efficient drainage.

The wiring block must be installed to current IEE standards and situated outside of IP Zones 0, 1 & 2.

Dovedale



Waste option C pictured

The Dovedale utilises an above floor gravity waste system which requires no floor excavation.

The tray comes with the waste gully ready plumbed and is available with four waste positions.

Where a pumped waste is required the company has developed a pump box to compliment the waste outlet design (see page14).

The Dovedale is provided with a choice of single door, tri-fold door or full height door enclosure and a removable access ramp.

Single Door*

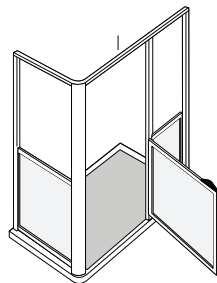
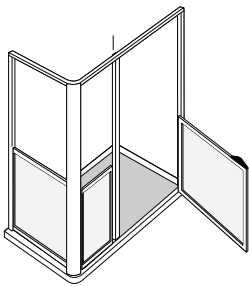

Tri-fold Door

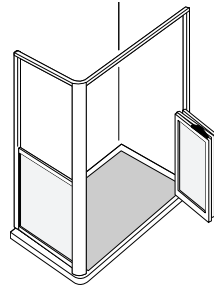

Full Height Door*

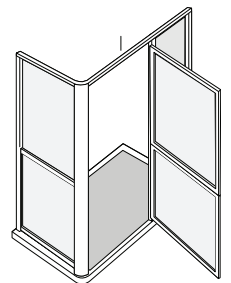
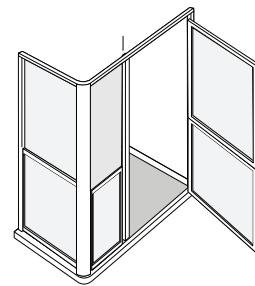

Tray waste option A illustrated.

* Single and full height door enclosures have a choice of configuration which can be selected at time of installation.

Tray Waste Position

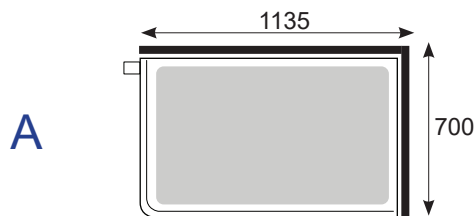

Installation



The Dovedale trays require no floor excavation, the trays are sited directly onto the floor and feature an integral gravity waste gully.

These trays have a gradual fall to the gully position to aid efficient waste water collection, which is evacuated via a 1 1/2" discharge pipe to be used in conjunction with a P/S trap.

Pump Box



The Chiltern Invadex pump box is used to provide a pumped waste option for the Dovedale trays.

The box incorporates a 12v waste pump and is provided with the necessary wiring block.

Compact and unobtrusive the pump box can be installed above or below floor level.

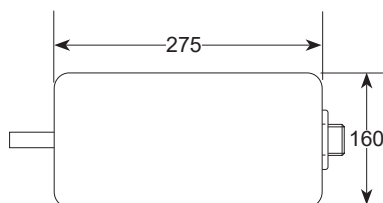
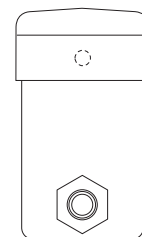
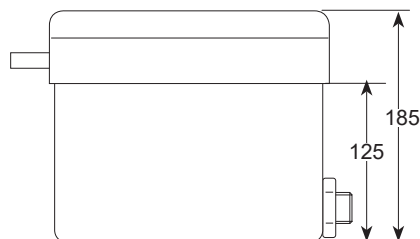

Palma Vita



The Clos-o-mat Palma Vita provides flushing, washing and drying facilities activated using an elbow pad.

Features

- **Soft-close seat**
- **Temperature-controlled shower water** The smart water heating with an energy-efficient boiler ensures that the shower water is perfectly temperature-controlled. For up to 45 seconds, even with shower flow rates up to 5 litres/minute.
- **Automatic flushing** This is triggered automatically after the start of the showering process.
- **Gentle cleaning lady-shower** The lady-shower function is triggered by touching the push-button, provides a much appreciated feeling of freshness. When the push-button is held down, the gentle shower spray can last for exactly as long as you wish. The air drying function starts automatically after showering.
- **Warm air drying** The temperature is gradually reduced. A pleasant feeling, as the drier the skin becomes, the cooler the air is.
- **Ambient light** The blue arc of light projected onto the floor indicates that the shower toilet is switched on. At night-time, the soft Closomat ambient light helps you find your way without having to put a bright light on.
- **Automatic odour extraction** Extraction starts when you sit down. Odours are neutralised by an active carbon filter
- **Optional wireless remote control**
- **Wellness programme** whilst the shower is running four wellness functions can switched on;



Touch once
Rotating shower spray



Touch twice
Pulsating shower spray



Touch 3 times
Temperature changing spray



Touch 4 times
All functions combined



Touch 5 times
Back to normal shower

Lima Vita

A wall mounted version of the Pama Vita.



A large range of accessories are available to ensure that the Palma Vita and Lima Vita can be customised for users with various physical conditions. These include support seats, straps and proxy switches.

Technical

Electrical installation should be in accordance with I.E.E. Regulations (Current Edition).

- 220/240v single phase AC supply is required, (loading 10 amp, maximum power 1300 watts). The Clos-o-Mat is supplied with 3 core cable attached. A fused spur is required for isolation
- Spur outlet to be located in accordance with current I.E.E. Regulations (Current Edition)
- Clos-o-Mat has an IPX4 rating

Full installation and technical details can be provided on request, please contact our Customer Services team on 01869 365500 opt 1 or email us at sales@chilterninvadex.co.uk.

Palma Vita

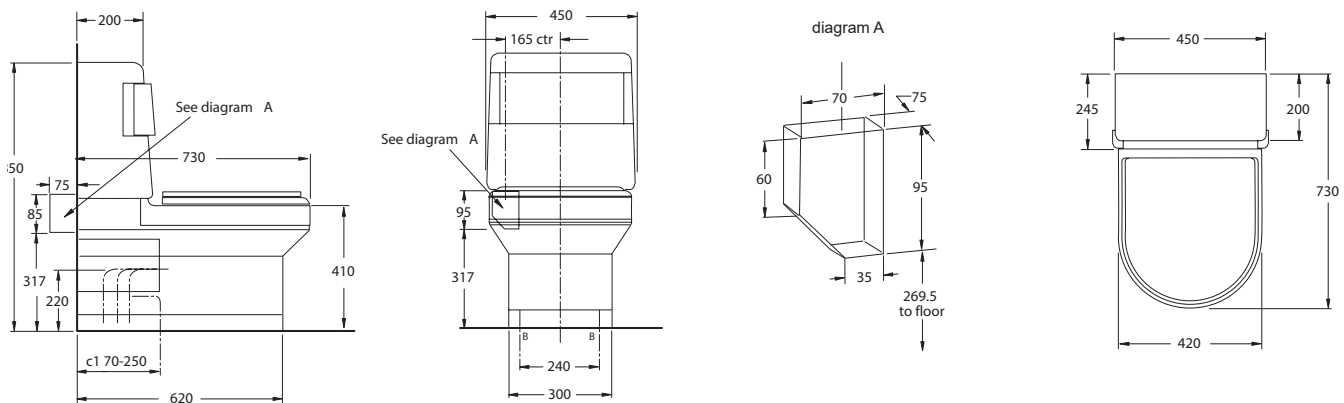

Lima Vita

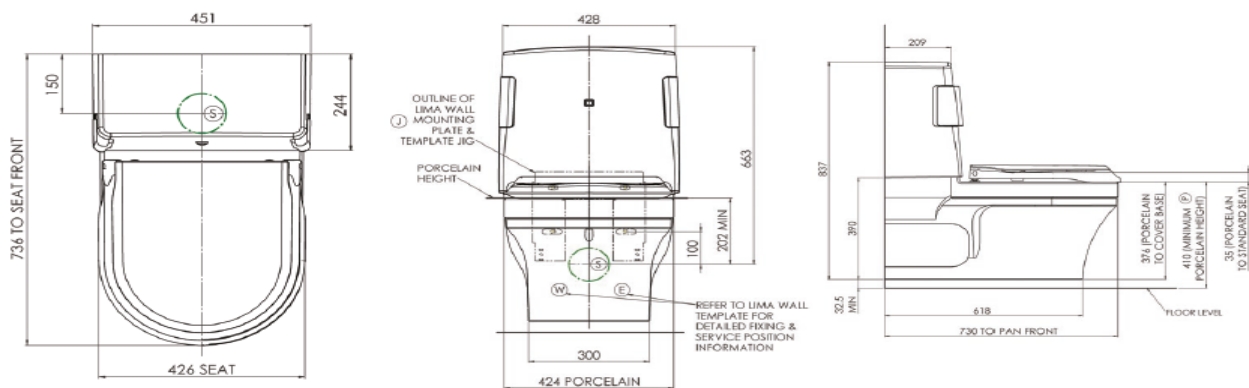

We manufacture a range of shower chairs and tilt in space chairs which have been designed specifically for use in conjunction with the Clos-o-Mat WC range, including bespoke, user specific models. See page 19 for details.



AquaClean Mera Classic



Features

- Individually adjustable spray settings
- Oscillating warm water spray arm
- Adjustable spray arm positioning
- Integral lady wash
- Touch free operation via remote
- Strengthened seat ideal for side transfer
- Warm air-dryer
- Programmable user profiles
- 2 Year warranty (optional extended warranties are available)

Three operating options for convenience



Remote



Wall mounted control panel

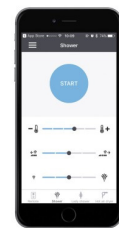

App

Additional Features

Cleaning with water

The extending spray arm of the WC will wash you with a gentle, oscillating or pulsating jet of warm water. The water temperature along with other features can be adjusted providing a pleasant experience, even for the most sensitive skin.

Oscillating spray

The forward and backward movement of the water spray ensures a particularly thorough clean.

Massage spray

The pulsating massage spray has a beneficial effect.

Lady wash

Combining the traditional features of a bidet, the lady wash provides a gentle clean.

Clean and hygienic

The spray nozzle is rinsed with fresh water before and after each use. This ensures spotless cleanliness at all times.

Warm and dry

After washing, the Geberit AquaClean Mera gently dries you with a flow of warm air. Drying is completed in minutes - leaving you feeling clean, fresh and confident.

Odour purification

Unpleasant odours will barely have time to circulate the room due to the efficient built in odour purification which is activated as soon as you sit down.

Total control

For added convenience the wash and dry cycle can be easily activated by either the push-button control panel located to the side or by using the remote control, providing maximum flexibility.

Touch-free operation

With the opto remote, using the Geberit AquaClean Mera can be completely hands-free. A sensor detects movement and automatically starts the washing and drying sequence. All functions will only operate you are seated. It will even flush the WC automatically before the wash programme - easy, private and convenient.

Personalised comfort

With the enhanced memory function on the remote control, you can select your own programme and store it, so that it can be used again and again. For added convenience, once saved the settings can be activated by the opto-remote or control panel. The remote also includes a button for flushing.

■ GEBERIT

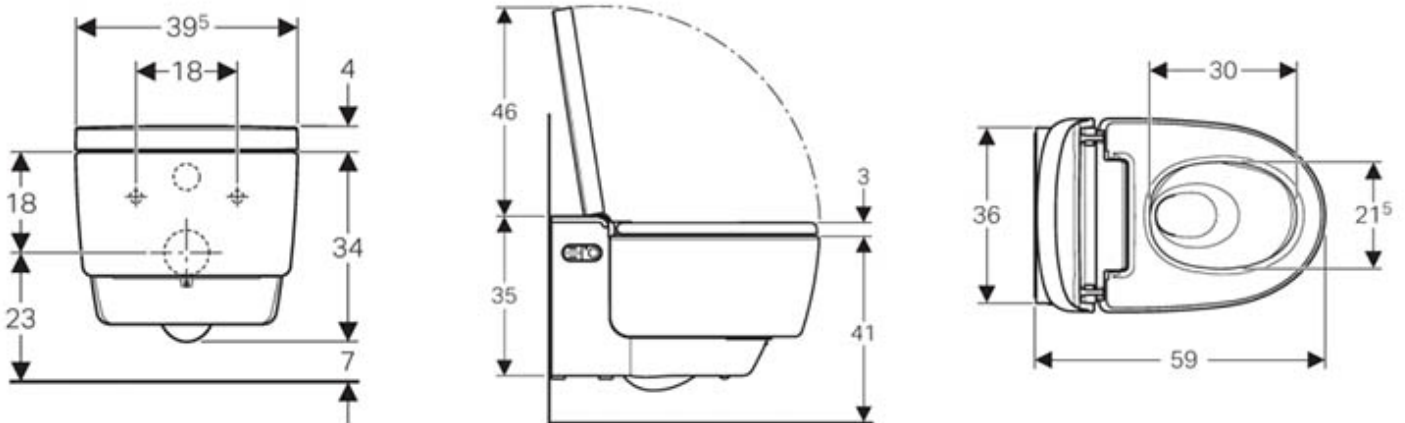

Electrical installation should be in accordance with I.E.E. Regulations (Current Edition).

- 230v single phase AC supply is required via non-switched fused spur outlet
- The AquaClean Mera has an IPX4 rating

Full installation and technical details can be provided on request, please contact our Customer Services team on 01869 365500 opt 1 or email us at sales@chilterninvadex.co.uk.



We are able to manufacture a range of shower chairs to suit the AquaClean Mera.

Please call customer services on 01869 365500 opt 1 for details.



Accessories







To compliment our range of bathing equipment, Chiltern Invadex can provide a range of accessories to enhance the bathing experience, making it safe and comfortable for users of varying abilities.

For full details of any of the products shown, please see our website at www.chilterninvadex.co.uk or contact our Customer Services team on 01869 365500 opt 1 or by email to sales@chilterninvadex.co.uk to obtain a product specific brochure.

Shower Chairs and Cradles

The Chiltern Invadex range of shower chairs and cradles has a proven track record for providing a safe and reliable bathing solution for wheelchair users.

Manufactured at our Oxfordshire facility, we are able to manufacture bespoke models to suit specific user needs.

Aquamaster 17", 19" & 21" widths				Paediatric 15"	Transaqua 18", 19" & 21"	
A02	A06	A08	A11	A20 & A21	TAAP	TASP
						

The A06, A11 and our Tilt in Space chair (below) are available as a Closomat model to suit the Palma Vita. Bespoke models can be manufactured on request.



Tilt in Space Shower Chair

A range of tilt in space shower chairs and cradles have been developed for use by those with more challenging needs.



Tilt in Space Shower Cradle

The AquaMaster and Tilt in Space ranges are available in both adult and paediatric sizes with numerous colour options on request.



A large range of accessories is available for all ranges.

Shower Trolleys & Stretchers

Our range of shower trolleys and stretchers are designed for use by those who need to be showered in the prone position. Bespoke models can be manufactured to suit user needs and property constraints.

Trolleys



Hydraulic model with standard grey liner

Static and height adjustable models are available. Height adjustment can be provided by hydraulic rams or electronically via a handset. All models have a drainage hose which can be placed into any waste water drain, no trolley specific plumbing is required.

Shower trolleys feature side rails for added security and a padded liner and head cushion for comfort.

Trolleys are available in two standard lengths to suit both adult and paediatric use.

Liners are available in a number of colour options.



Stretchers

Shower stretchers are wall mounted and can be used over a bath or in a wet room scenario. They have been designed to fold securely against the wall when not in use, ensuring that bathing facilities can be used by multiple users of varying abilities.

Three standard models are available, T11 is a flat bed stretcher, T12 has a variable height backrest and the T13 which features a padded liner, cot side and drainage hose. The T13 can be provided with a coloured liner and head cushion.



T11



T12



T13

The new T17 folding stretcher is a transportable model featuring:

- 4 braked (optional directional lock castor)
- 3 levels of height adjustment
- Head cushion
- Easy clean soft vinyl top with drainage holes
- Can be folded flat for storage
- Optional side rails



T17

Shower Units



Mira Advance ATL Flex Extra

- Mira Advance ATL Flex Extra 9Kw electric shower has a push button stop and flow controls which are independent of the temperature dial
- Safe showering with precise thermostatic control for constant water temperature
- ATL - Adjustable Temperature Limit for added safety
- Instantly heats water to guarantee a hot shower every time
- Smooth slide bar with easy glide operation
- Additional handset holder for flexible showering heights

Mira Excel

- Showering with precise thermostatic control, recognising and compensating for changes in water temperature to provide an extremely safe and satisfying shower
- Easy installation features save time and installation costs
- Includes maximum temperature stop for safe showering



SaniPRO XR Up Small Bore Macerator



- Breaks down waste from a shower, wash basin or W.C for pumping away through a small bore (22mm) pipe
- A powerful motor enables the unit to pump the waste and water up to 5m vertically, 100m horizontally or a lesser combination of both, where conventional large bore pipework is impractical
- Features a new case with sound reduction and integrated carbon filter
- Can be used with Whale pump option

Shower Screen

The Chiltern Invadex Portascreen is designed for use in a wet room environment. The half height screen enables carers to assist with bathing whilst protecting them from splashes. Available in two sizes, the portascreen is compact and free standing, it can be easily folded and stored when not in use.





Chiltern Invadex (UK) Ltd

Unit 6C Thorpe Drive
Banbury
Oxfordshire
OX16 4UZ
Tel: 01869 365500

E-mail: sales@chilterninvadex.co.uk
Web: www.chilterninvadex.co.uk

Overseas enquiries
Tel: 0044 1869 365500

Other products available from Chiltern Invadex;

Moving and Handling Range

Ceiling mounted hoists
Slings
Mobile Hoist
Portable Hoist

To obtain a brochure or request a free of charge survey visit please contact customer services on 01869 365500 Opt 1 or email sales@chilterninvadex.co.uk.

